



# USB3.0 Board Level Camera

User Manual

# Legal Information

## User Manual

© 2019 Hangzhou Hikrobot Technology Co., Ltd. All rights reserved.

## About This Manual

The Manual includes instructions for using and managing the Product. Pictures, charts, images and all other information hereinafter are for description and explanation only. The information contained in the Manual is subject to change, without notice, due to firmware updates or other reasons. Please find the latest version of this Manual at the Hikrobot website (<https://www.hikrobotics.com/>).

Please use this Manual with the guidance and assistance of professionals trained in supporting the Product.

## Trademarks

**HIKROBOT** and other Hikrobot's trademarks and logos are the properties of Hikrobot in various jurisdictions. Other trademarks and logos mentioned are the properties of their respective owners.

## Disclaimer

TO THE MAXIMUM EXTENT PERMITTED BY APPLICABLE LAW, THIS MANUAL AND THE PRODUCT DESCRIBED, WITH ITS HARDWARE, SOFTWARE AND FIRMWARE, ARE PROVIDED “AS IS” AND “WITH ALL FAULTS AND ERRORS”. HIKROBOT MAKES NO WARRANTIES, EXPRESS OR IMPLIED, INCLUDING WITHOUT LIMITATION, MERCHANTABILITY, SATISFACTORY QUALITY, OR FITNESS FOR A PARTICULAR PURPOSE. THE USE OF THE PRODUCT BY YOU IS AT YOUR OWN RISK. IN NO EVENT WILL HIKROBOT BE LIABLE TO YOU FOR ANY SPECIAL, CONSEQUENTIAL, INCIDENTAL, OR INDIRECT DAMAGES, INCLUDING, AMONG OTHERS, DAMAGES FOR LOSS OF BUSINESS PROFITS, BUSINESS INTERRUPTION, OR LOSS OF DATA, CORRUPTION OF SYSTEMS, OR LOSS OF DOCUMENTATION, WHETHER BASED ON BREACH OF CONTRACT, TORT (INCLUDING NEGLIGENCE), PRODUCT LIABILITY, OR OTHERWISE, IN CONNECTION WITH THE USE OF THE PRODUCT, EVEN IF HIKROBOT HAS BEEN ADVISED OF THE POSSIBILITY OF SUCH DAMAGES OR LOSS.

YOU ACKNOWLEDGE THAT THE NATURE OF INTERNET PROVIDES FOR INHERENT SECURITY RISKS, AND HIKROBOT SHALL NOT TAKE ANY RESPONSIBILITIES FOR ABNORMAL OPERATION, PRIVACY LEAKAGE OR OTHER DAMAGES RESULTING FROM CYBER-ATTACK, HACKER ATTACK, VIRUS INSPECTION, OR OTHER INTERNET SECURITY RISKS; HOWEVER, HIKROBOT WILL PROVIDE TIMELY TECHNICAL SUPPORT IF REQUIRED.

YOU AGREE TO USE THIS PRODUCT IN COMPLIANCE WITH ALL APPLICABLE LAWS, AND YOU ARE SOLELY RESPONSIBLE FOR ENSURING THAT YOUR USE CONFORMS TO THE APPLICABLE LAW. ESPECIALLY, YOU ARE RESPONSIBLE, FOR USING THIS PRODUCT IN A MANNER THAT DOES NOT INFRINGE ON THE RIGHTS OF THIRD PARTIES, INCLUDING WITHOUT LIMITATION, RIGHTS OF PUBLICITY, INTELLECTUAL PROPERTY RIGHTS, OR DATA PROTECTION AND OTHER PRIVACY RIGHTS.

YOU SHALL NOT USE THIS PRODUCT FOR ANY PROHIBITED END-USES, INCLUDING THE DEVELOPMENT OR PRODUCTION OF WEAPONS OF MASS DESTRUCTION, THE DEVELOPMENT OR PRODUCTION OF CHEMICAL OR BIOLOGICAL WEAPONS, ANY ACTIVITIES IN THE CONTEXT RELATED TO ANY NUCLEAR EXPLOSIVE OR UNSAFE NUCLEAR FUEL-CYCLE, OR IN SUPPORT OF HUMAN RIGHTS ABUSES.

THE PERFORMANCE DATA IN THIS PUBLICATION IS BASED ON HIKROBOT'S INTERNAL RESEARCH/EVALUATION. ACTUAL DATA MAY VARY DEPENDING ON SPECIFIC CONFIGURATIONS AND OPERATING CONDITIONS AND HIKROBOT SHALL NOT BEAR THE CONSEQUENCES ARISING THEREFROM.

IN THE EVENT OF ANY CONFLICTS BETWEEN THIS MANUAL AND THE APPLICABLE LAW, THE LATER PREVAILS.

## Regulatory Information

### FCC Information

Please take attention that changes or modification not expressly approved by the party responsible for compliance could void the user's authority to operate the equipment.

**FCC compliance:** This equipment has been tested and found to comply with the limits for a Class A digital device, pursuant to part 15 of the FCC Rules. These limits are designed to provide reasonable protection against harmful interference in a residential installation. This equipment generates, uses and can radiate radio frequency energy and, if not installed and used in accordance with the instructions, may cause harmful interference to radio communications. However, there is no guarantee that interference will not occur in a particular installation. If this equipment does cause harmful interference to radio or television reception, which can be determined by turning the equipment off and on, the user is encouraged to try to correct the interference by one or more of the following measures:

- Reorient or relocate the receiving antenna.
- Increase the separation between the equipment and receiver.
- Connect the equipment into an outlet on a circuit different from that to which the receiver is connected.
- Consult the dealer or an experienced radio/TV technician for help.

### FCC Conditions

This device complies with part 15 of the FCC Rules. Operation is subject to the following two conditions:

1. This device may not cause harmful interference.
2. This device must accept any interference received, including interference that may cause undesired operation.

## EU Conformity Statement

**CE** This product and - if applicable - the supplied accessories too are marked with "CE" and comply therefore with the applicable harmonized European standards listed under the EMC Directive 2014/30/EU, LVD Directive 2014/35/EU, the RoHS Directive 2015/863/EU amending 2011/65/EU.



2012/19/EU (WEEE directive): Products marked with this symbol cannot be disposed of as unsorted municipal waste in the European Union. For proper recycling, return this product to your local supplier upon the purchase of equivalent new equipment, or dispose of it at designated collection points. For more information see: [www.recyclethis.info](http://www.recyclethis.info)



2006/66/EC (battery directive): This product contains a battery that cannot be disposed of as unsorted municipal waste in the European Union. See the product documentation for specific battery information. The battery is marked with this symbol, which may include lettering to indicate cadmium (Cd), lead (Pb), or mercury (Hg). For proper recycling, return the battery to your supplier or to a designated collection point. For more information see: [www.recyclethis.info](http://www.recyclethis.info)

## Symbol Convention

The symbols that may be found in this document are defined as follows.

Symbol	Description
<b>NOTE</b>	Provides additional information to emphasize or supplement important points of the main text.
<b>WARNING</b>	Indicates a potentially hazardous situation, which if not avoided, could result in equipment damage, data loss, performance degradation, or unexpected results.
<b>DANGER</b>	Indicates a hazard with a high level of risk, which if not avoided, will result in death or serious injury.

## Available Model

This manual is applicable to the USB3.0 Board Level Camera.

## Safety Instructions

These instructions are intended to ensure that the user can use the device correctly to avoid danger or property loss.

### Laws and Regulations

The device should be used in compliance with local laws, electrical safety regulations, and fire prevention regulations.

### Power Supply

- When wiring or dismantling, make sure that the device power is cut off, and do not operate under electrification.
- Avoid contact with exposed circuit. When the device is powered on, avoid contact with exposed junctions and parts.
- Use the power adapter provided by the regular manufacturer.
- Do not connect multiple devices to one power adapter, to avoid over-heating or fire hazards caused by overload.
- Make sure the plug is properly connected to the power socket.

### Transportation

- The device contains precision optical components and electronic components. During transportation, storage and installation, incorrect operations like heavy pressure and violent vibration should be avoided. Otherwise, the device may be damaged.
- Avoid sudden collision, and pack the device with the accompanied carton and cushioning material or similar package.

### Using Environment

- In order to reduce the risk of fire or electric shock, do not let the device get wet or damp.
- Do not drop objects onto the device and avoid vigorous vibration.
- Keep the device away from magnetic interference.
- Do not use the device in extremely heat, extremely cold, dusty environment, corrosive environment or high humidity environment.
- Do not aim the device lens at objects of strong light, such as the sun and incandescent lamp. Otherwise, the lens may be damaged.
- The device should be stored in dry environment without corrosive gas. Avoid placing the device in direct sunlight and poorly ventilated locations, or near heat sources such as heater or heating (ignoring this warning may lead to fire hazards).
- Do not operate in explosive environment.
- Keep the surrounding area well ventilated to avoid heat accumulation. Do not contact the radiator directly to avoid scald.

### Electrostatic Protection

- Remove all conductive objects (such as jewelry, watch, etc.) on the device body before touching the device, and touch the grounding metal bracket by hand to release the static electricity.

- It is suggested to wear anti-static suit to prevent damage to the equipment caused by static electricity.
- When installing or maintaining the device, wear anti-static wristband or anti-static gloves. Make sure that the wristband is tightly attached to the skin and is reliably grounded.
- It is forbidden to touch exposed circuit boards with bare hands. Static electricity generated by human body may damage electrostatic sensitive components on circuit boards.
- When touching electrostatic sensitive components or devices, proper grounding measures must be taken.
- Put electrostatic sensitive components into anti-static bags for protection.
- It is suggested to place humidifier in dry environment to maintain suitable humidity and reduce static electricity generation.

## **Maintenance**

- If the device is not working properly, contact the store or the nearest service center. Do not disassemble or modify the device in any way. (The company does not bear any liability for any problem arising from unauthorized modification or maintenance).
- Properly preserve all the original packaging materials of the device so that when problems arise, the device can be packed with packaging materials and sent to the agent or returned to the manufacturer for processing. The company does not bear any liability for accidental damage during transportation caused by non-original packaging.
- This device is a precision electronic device, no components can be maintained by user, do not disassemble the device arbitrarily.

## **Cleaning**

Do not touch the image sensor directly. If the sensor needs to be cleaned, use a clean rag and wet it with alcohol, then gently wipe off the dirt; if the device is not in use, cover the image sensor with dust cover for protection.

## **Installation**

Do not install the device on vibrating surface or places that are vulnerable to impact.

## **Personnel Requirement**

Quality requirements for installation and maintenance personnel: qualification certificate or working experience in weak current system installation and maintenance, and relevant working experience and qualifications. Besides, the personnel must possess the following knowledge and operation skills:

- The basic knowledge and operation skills of low voltage wiring and low voltage electronic circuit connection.
- The ability to comprehend the contents of this manual.

## **Contact Information**

Hangzhou Hikrobot Technology Co., Ltd.

No. 399 Danfeng Road, Binjiang District, Hangzhou, 310051, China

E-mail: [tech\\_support@hikrobotics.com](mailto:tech_support@hikrobotics.com)

Website: [en.hikrobotics.com](http://en.hikrobotics.com)

# Table of Contents

<b>Chapter 1 Overview</b> .....	<b>1</b>
1.1 Appearance .....	1
1.2 I/O Interface .....	2
1.3 Indicator Description.....	3
<b>Chapter 2 Camera Installation</b> .....	<b>5</b>
2.1 Install Camera .....	5
<b>Chapter 3 Client Installation</b> .....	<b>6</b>
3.1 Install MVS.....	6
3.2 Check Driver .....	6
<b>Chapter 4 Live View</b> .....	<b>8</b>
<b>Chapter 5 Camera Settings</b> .....	<b>9</b>
5.1 Main Window .....	9
5.2 Set Parameters.....	10
<b>Chapter 6 Main Operations</b> .....	<b>12</b>
6.1 Device Control .....	12
6.2 Image Format and Frame Rate .....	14
6.2.1 Set Image Format.....	14
6.2.2 Set Frame Rate.....	14
6.2.3 Set Region of Interest .....	15
6.2.4 Set Binning.....	16
6.2.5 Set Decimation.....	16
6.3 Global Shutter and Rolling Shutter .....	17
6.3.1 Global Shutter .....	17
6.3.2 Rolling Shutter .....	18
6.4 Image Acquisition and Transmission.....	19
6.4.1 Set Acquisition Mode .....	19
6.4.2 Set Trigger Mode.....	19
6.4.3 Set External Trigger and Work Mode .....	20
6.5 Set Strobe Output .....	23
6.6 Acquisition Mode under External Trigger .....	25
6.6.1 Single Frame Mode .....	25
6.6.2 Burst Mode .....	25
6.7 Non-overlap Exposure and Overlap Exposure.....	26



6.7.1 Non-overlap Exposure.....	26
6.7.2 Overlap Exposure .....	26
6.8 Counter and Timer Control .....	27
6.9 Image Parameter Setting.....	29
6.9.1 Set Exposure Time .....	29
6.9.2 Set Gain .....	30
6.9.3 Set White Balance .....	31
6.9.4 Set Auto Function AOI .....	32
6.9.5 Set LUT.....	33
6.9.6 Set Gamma Correction .....	33
6.9.7 Set Brightness, Hue, Saturation and Sharpness.....	34
6.9.8 Set Image Reverse .....	35
6.9.9 Set HDR Polling .....	36
6.9.10 Set Test Mode .....	37
6.9.11 Set Black Level.....	40
6.9.12 Set Digital Shift.....	40
6.9.13 Embedded Information in Image .....	40
6.10 I/O Electrical Feature and Wiring .....	42
6.10.1 I/O Electrical Feature.....	42
6.10.2 I/O Wiring .....	45
6.11 Parameter Set Customization .....	47
6.11.1 Save and Load User Set .....	47
6.12 Firmware Update .....	49
<b>Chapter 7 Trouble Shooting.....</b>	<b>51</b>
<b>Chapter 8 Revision History .....</b>	<b>52</b>

# Chapter 1 Overview

## 1.1 Appearance

The USB3.0 board level camera possesses 3 kinds of appearance as shown below. Type I is the board structure, type II is the C-mount structure, and type III is the M12-mount structure. These appearances are subject to change, and the actual device you purchased shall govern.

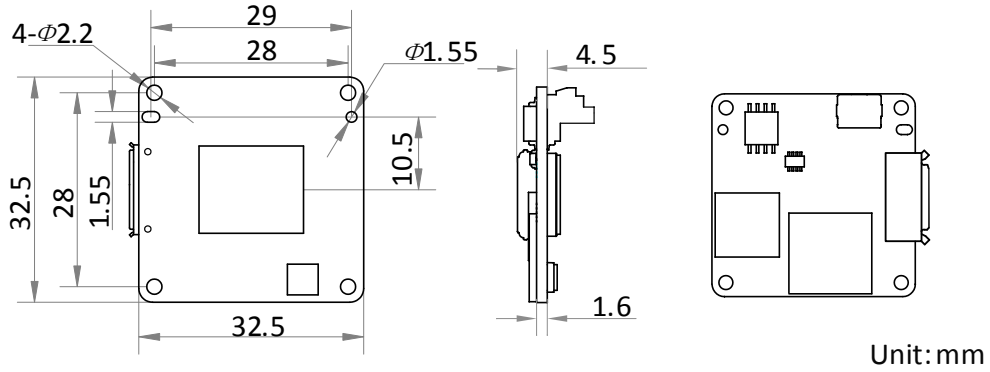

Figure 1-1 Appearance (Type I)

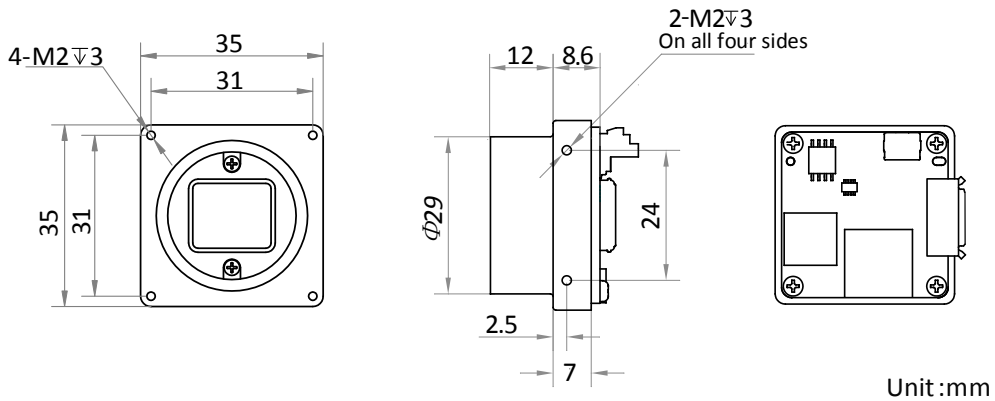

Figure 1-2 Appearance (Type II)

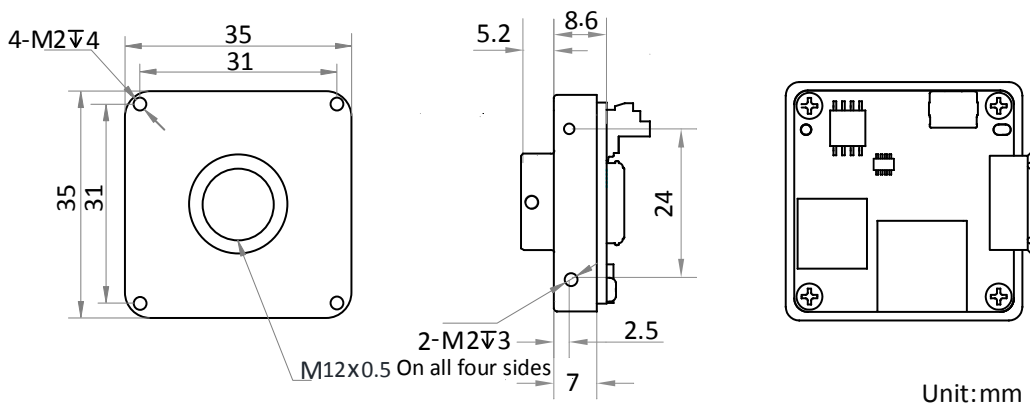

Figure 1-3 Appearance (Type III)

The interfaces in back side of board level camera and interface description are shown in Figure 1-4.

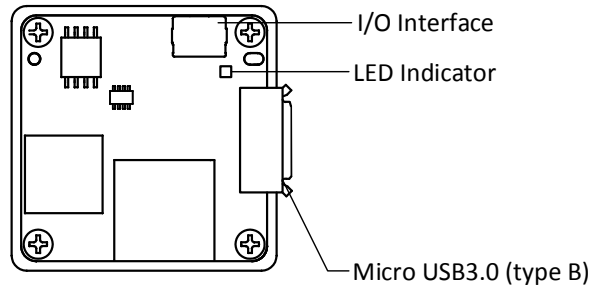

Figure 1-4 Camera Interface

**NOTE**

- The C-mount camera can connect to a C-mount lens. Its back focal length is  $17.45 \text{ mm} \pm 0.15 \text{ mm}$ .
- For specific interfaces in back side of board level camera, the actual device you purchased shall govern.

## 1.2 I/O Interface

The USB3.0 board level camera possesses 2 kinds of I/O interface, which are 6-pin and 4-pin. For specific feature, the actual device you purchased shall govern.

The description of the 6-pin I/O interface is shown in Table 1-1.

Table 1-1 6-pin I/O Interface Description

Illustration	Pin	Signal	I/O Type	I/O Signal Source	Description
<p>The illustration shows a 6-pin connector with pins numbered 1 to 6. Pin 1 is at the top left, pin 2 at the top right, pin 3 at the middle left, pin 4 at the middle right, pin 5 at the bottom left, and pin 6 at the bottom right.</p>	1	GPIO2	Input or output	Line 2 signal line	Can be configured either as input or output
	2	Reserved	Reserved	--	--
	3	GPIO1	Input or output	Line 1 signal line	Can be configured either as input or output
	4	Gnd	Input or output	Line 1 and Line 2 signal ground	Signal ground
	5	Reserved	Reserved	--	--
	6	Reserved	Reserved	--	--

The description of the 4-pin I/O interface is shown in Table 1-2.

Table 1-2 4-pin I/O Interface Description

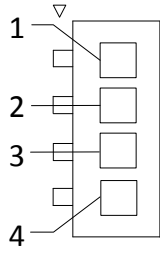
Illustration	Pin	Signal	I/O Type	I/O Signal Source	Description
	1	Reserved	Reserved	--	--
	2	Gnd	Input or output	Line 1 and Line 2 signal ground	Signal ground
	3	GPIO1	Input or output	Line 1 signal line	Can be configured either as input or output
	4	GPIO2	Input or output	Line 2 signal line	Can be configured either as input or output

### 1.3 Indicator Description

The indicator has different status, and please refer to the following table for the details.

Table 1-3 Status Definition

Indicator Status	Description
Light up	Indicator lights up for 5 seconds.
Solid	Indicator keeps solid.
Unlit	Indicator keeps unlit.
Fast flash	Unlit interval is 200 ms to 300 ms.
Slow flash	Unlit interval is 1000 ms.
Very slow flash	Unlit interval is 2000 ms.

Table 1-4 Indicator Status Description

Camera Status	Red LED Indicator Status	Blue LED Indicator Status	Description
Camera is powered off.	---	---	---
Connection error.	Very slow Flash	---	Data cable is disconnected.

Camera Status	Red LED Indicator Status	Blue LED Indicator Status	Description
Camera is in idle status.	---	Solid	Data cable has connected, and the camera is ready.
Internal triggering acquisition, and U3 is in transmission status.	---	Flash Fast	Data cable has connected, and camera is acquiring images under internal triggering mode. Data transmission speed reaches the rated speed of USB3.0 port.
Internal triggering acquisition, and U2 is in transmission status.	---	Slow flash	Data cable has connected, and camera is acquiring images under internal triggering mode. Data transmission speed reaches the rated speed of USB2.0 port.
External triggering acquisition status.	---	Very slow flash	Data cable has connected, and camera is acquiring images under external triggering mode.
Firmware is updating.	Red LED and blue LED flash alternatively with 1 second duration.		When red LED and blue LED flash alternatively, firmware is updating.
Firmware updating failed or error.	Solid	---	Firmware updating failed, or configuration file reading failed, or other errors.
Camera's current status (Find Me function).	Light up	---	When executing Find Me function via client software, the camera lights up for one time.

## Chapter 2 Camera Installation

### 2.1 Install Camera

The camera adopts the USB3.0 interface, and you need to use the USB3.0 cable to guarantee the bandwidth for real-time image transmission.

#### ***Before you start***

Make sure all the related devices are power-off during the installation. Use the USB cable to connect the camera to the computer via USB3.0 interface to power up the camera.

#### ***Steps:***

1. Open the camera package and fix it to the mounting position.
2. Use Micro USB3.0 (type B) cable to connect the camera to the computer.



#### **WARNING**

The camera is powered by the external DC power supply (USB 3.0, 5VDC, 0.9 A) which is complied with the LPS, and the output current of this external DC power supply must be no more than 3 A.

## Chapter 3 Client Installation

### 3.1 Install MVS

#### NOTE

- The MVS client software is compatible with 32/64-bit Windows XP/7/10, 32/64-bit Linux, and 64-bit MacOS operating systems. Here we take Windows as an example.
- Software version in this manual is V3.1.0. If other versions are used, the graphic user interface may differ.
- You can download the client software installation package from *en.hikrobotics.com*.

#### **Steps:**

1. Double-click MVS installation package to install the client.
2. Read the **Terms of the License Agreement** and check it.

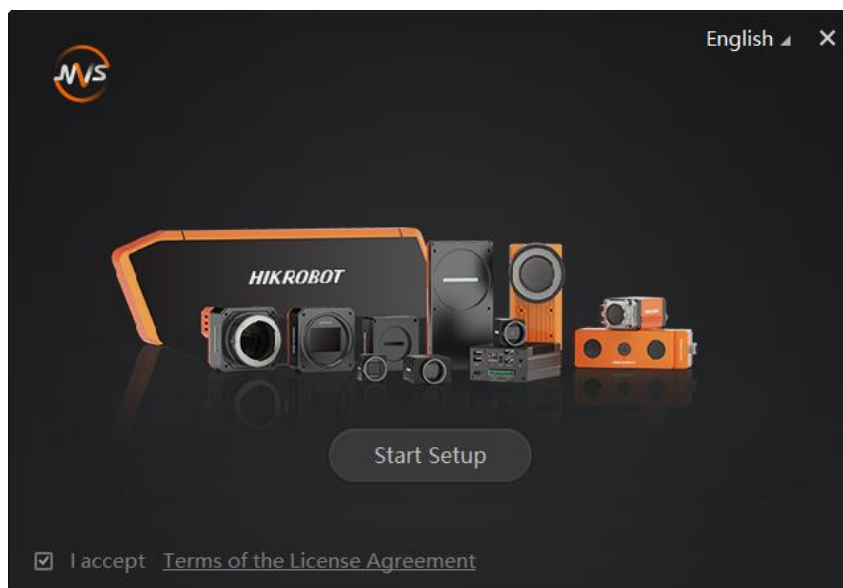

Figure 3-1 Installation Interface

3. Click **Start Setup**.

### 3.2 Check Driver

After connecting the camera, the PC will automatically install USB3 Machine Vision Camera driver. You can view that camera driver has been successfully installed in the Windows device manager by right-clicking on camera driver, as shown in Figure 3-2.

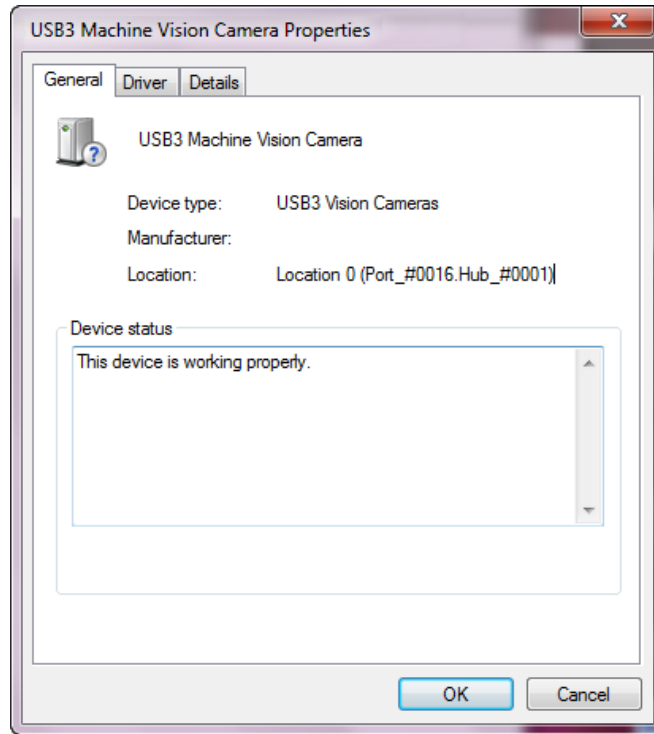

Figure 3-2 Camera Driver Properties

If the driver is not successfully installed as shown above, you need to install it manually. The driver is at C:\Program Files (x86) \Common Files\MVS\Drivers\Usb3.0 by default.



 **NOTE**

The location of the driver depends on the directory you selected and the computer operating system you used when installing the client.



## Chapter 4 Live View

If the live view is normal, the camera is connected to the MVS. You can use the camera as you need. If not, please refer to the former steps and repeat again.

After running the MVS client software, you can click  to connect the camera, and then click  to have the live view, as shown below.

 **NOTE**

Software version in this manual is V3.1.0. If other versions are used, the graphic user interface and icon may differ.

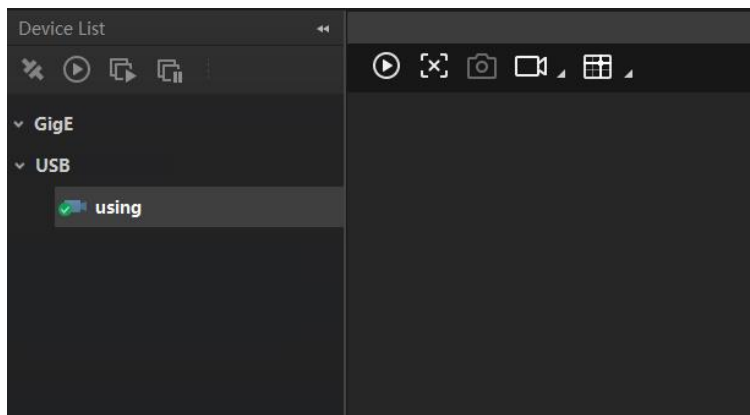









Figure 4-1 Live View in the MVS

Table 4-1 Icon Description

No.	Icon	Description
1		Connect or disconnect camera.
2		Start or stop acquisition.
3		Start batch acquisition.
4		Stop batch acquisition.
5		Start or stop live view.
6		Capture and save pictures.
7		Start recording.
8		Show cross line.

## Chapter 5 Camera Settings

### 5.1 Main Window

The software can read the XML file of camera attributes and display them in tree format.

Run the MVS client software to enter its main window. The main window and the description of the client software are shown in Figure 5-1 and Table 5-1.

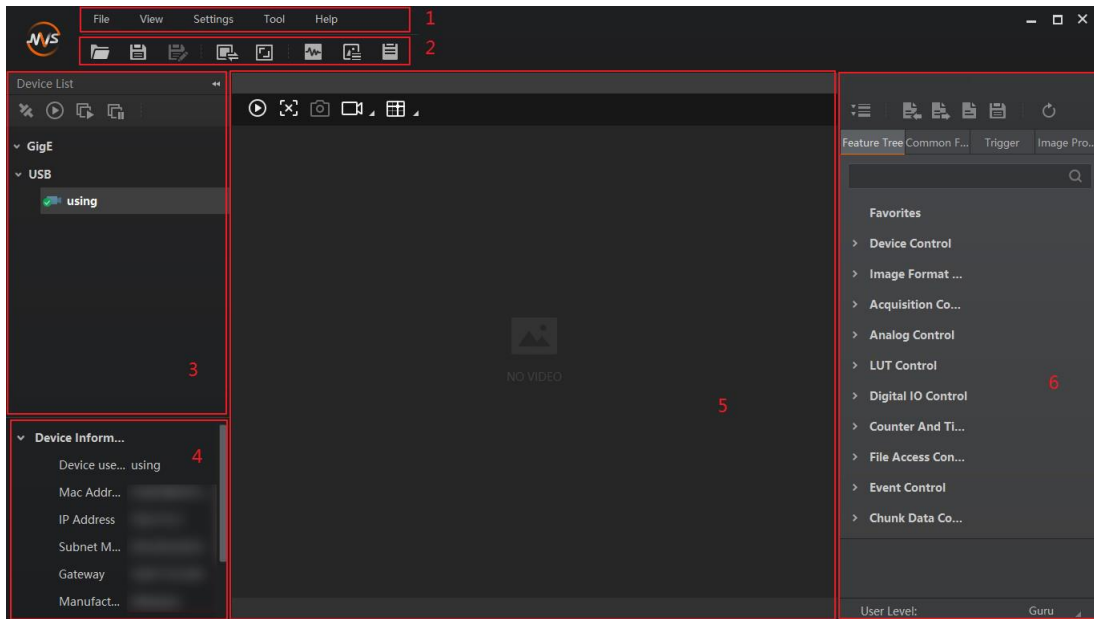

Figure 5-1 Main Window of the Client Software

 **NOTE**

For specific main window of the client software, please refer to the actual one you run.

Table 5-1 Description of the Main Window

No.	Area Name	Description
1	Menu Bar	Function modules including File, View, Settings, Tool, and Help.
2	Control Toolbar	The control toolbar provides quick operations for camera images.
3	Device List Panel	Display the GigE Vision cameras, USB3 Vision cameras, and Camera Link cameras. And provide icons for connecting/disconnecting camera, start/stop acquisition, and refreshing device list.

No.	Area Name	Description
4	Interface and Device Information Panel	Display the network interface information and the device information.
5	Display Window	View the live video of the selected camera.
6	Feature Panel	View and configure features of the selected camera, and perform other operations such as importing, exporting, and saving features.

## 5.2 Set Parameters

The camera setting supports 3 kinds of user level: Beginner, Expert or Guru, which displays different camera attributes. For Guru Level, it provides the most comprehensive camera attributes for professional use. Here we take Guru Level as an example.

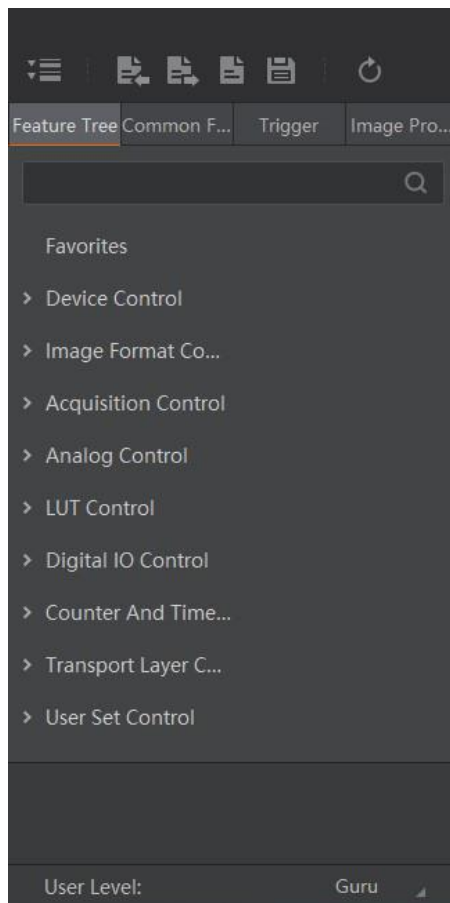

Figure 5-2 Attribute Page

- **Device Control:** You can view the camera details including device type, version, manufacturer details, device ID, device alias, device temperature, etc. You can reset the device or find the device.
- **Image Format Control:** You can view the live view image width and height, pixel size, etc. You can modify the image reverse status, test pattern and the embedded information, etc.
- **Acquisition Control:** You can set the trigger mode, trigger source, exposure details, etc.
- **Analog Control:** You can adjust analog gain, black level, brightness, gamma, sharpness, AOI, etc.
- **LUT Control:** You can view the user lookup table and set the LUT index and value.
- **Digital IO Control:** You can manage the digital input and output.
- **Counter and Timer Control:** You can set the counter and timer function. It can count the triggering signal and control the exposure according to the user needs.
- **Transport Layer Control:** You can set the parameters of transport layer of the camera.
- **Stream Control:** You can see the data on data header, effective load, and data tail.
- **User Set Control:** You can save or load the parameter configuration set by users. You can set the default parameter when running the software.



**NOTE**

The specific parameters vary from device to device and are subject to the actual ones.

## Chapter 6 Main Operations

### 6.1 Device Control

In Device Control interface, you can view device information, edit device name, reset device and etc, as shown below. Some device control parameters are listed in Table 6-1.

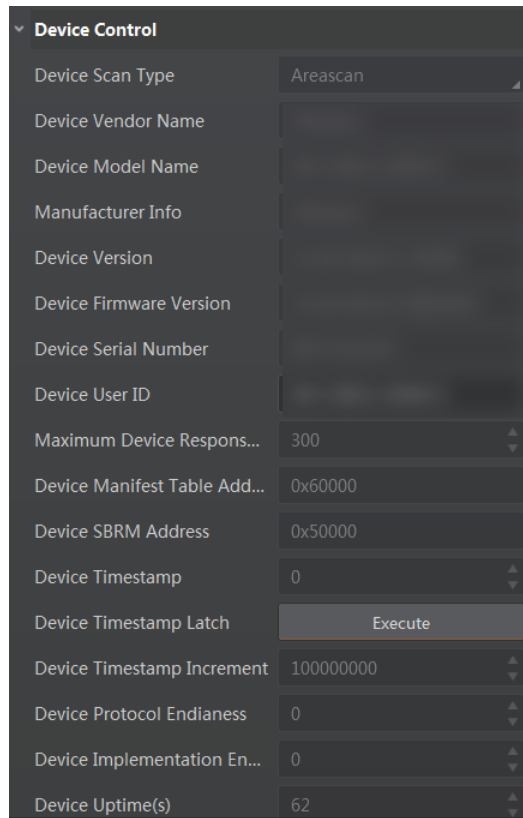

Figure 6-1 Device Control Interface

Table 6-1 Device Control Description

Parameter	Read/Write	Description
Device Scan Type	Read only	Device scan type.
Device Vendor Name	Read only	Device manufacturer.
Device Model Name	Read only	Device model.
Device Manufacturer Info	Read only	Device manufacturer information.
Device Version	Read only	Device firmware version.

Parameter	Read/Write	Description
Device Serial Number	Read only	Device serial number.
Device User ID	Read and write	Device name and it is empty by default. You can set according to your preference. If User ID is empty, the client software displays camera name in the form of “model+ serial number”. If User ID is not empty, the client software displays camera name in the form of “User ID content+ serial number”.
Device Timestamp	Read only	The timestamp counts the number of ticks generated by the camera's internal device clock.
Device Uptime(s)	Read only	The period of time when device is powered up.
Device Connection Status	Read only	Device connection status.
Device Link Current Throughput	Read only	The current transmission bandwidth of device.
Device Sensor Throughput Limit	Read and write	Device flow control and it can be set according to actual bandwidth. There are six kinds of bandwidth speed you can select, such as, 0.75 Gbps, 1.00 Gbps and etc.
Device Command Timeout	Read only	Device maximum response time.
Device Stream Channel Count	Read only	The number of device stream channel.
Device Reset	Write	Reset device by clicking Execute.
Find Me	Write	Click Execute to let red indicator flash, and find device.
Device Max Throughput	Read only	The maximum flow of device operation.

 **NOTE**

The specific parameters vary from device to device and are subject to the actual ones.

## 6.2 Image Format and Frame Rate

The camera supports different image formats and you can set region of interest in the image. Setting region of interest will increase frame rate.

### 6.2.1 Set Image Format

The USB3.0 board level camera supports many pixel formats. For specific pixel formats that your camera supports, please refer to the Specifications of the camera which is available in [en.hikrobotics.com](http://en.hikrobotics.com).

#### NOTE

Bayer8 is the output pixel format for color cameras by default, and Mono8 is the output pixel format for mono cameras by default.

In client software, you can click **Image Format Control > Pixel Format**, view the pixel formats that your camera supports, and select one that satisfies your need as shown below.

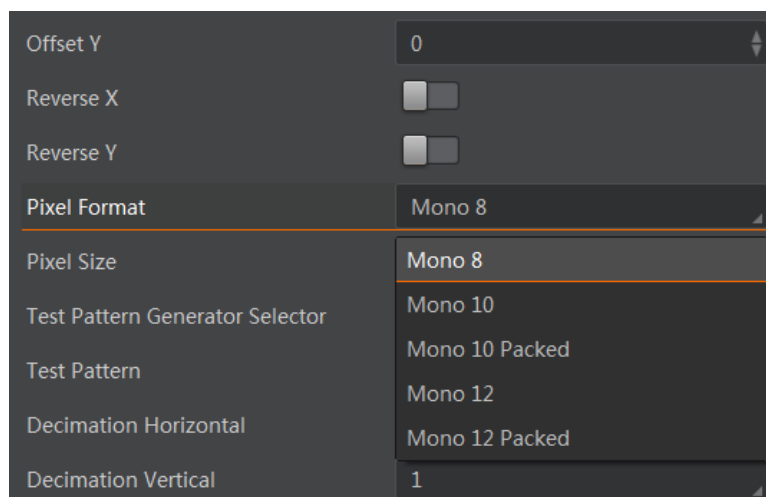

Figure 6-2 Set Pixel Format

#### NOTE

Pixel format can be set only when you stop real-time acquisition.

### 6.2.2 Set Frame Rate

The maximum frame rate the camera can achieve depends on the following 3 factors:

- **Frame Readout:** the lower the image height, the shorter the readout time, and thus the higher the frame rate.
- **Exposure Time:** the shorter the exposure time, the higher the frame rate.
- **Bandwidth:** a wider bandwidth can transport more frames in a given period of time.

In client software, you can set a desired acquisition frame rate as shown below.

**Steps:**

1. Click **Acquisition Control** -> **Acquisition Frame Rate**.
2. Input an appropriate acquisition frame rate.

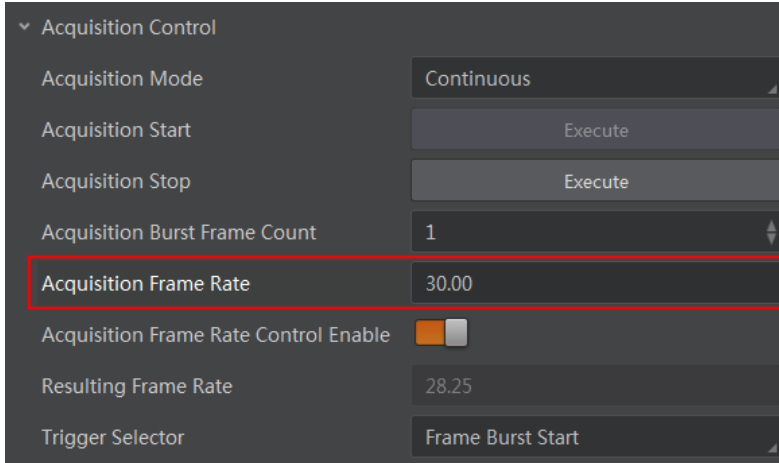

Figure 6-3 Set Frame Rate

### 6.2.3 Set Region of Interest

If you are only interested in a certain region of the image, you can set a region of interest (ROI) for the camera. Setting region of interest can reduce the bandwidth of the image being transmitted, thus increase the frame rate.

You can set the height and width of the ROI as shown below. Offset X and Offset Y are the coordinates of the upper left corner of the ROI.

**Steps:**

1. Click **Image Format Control**.
2. Set the value in **Width** and **Height**.

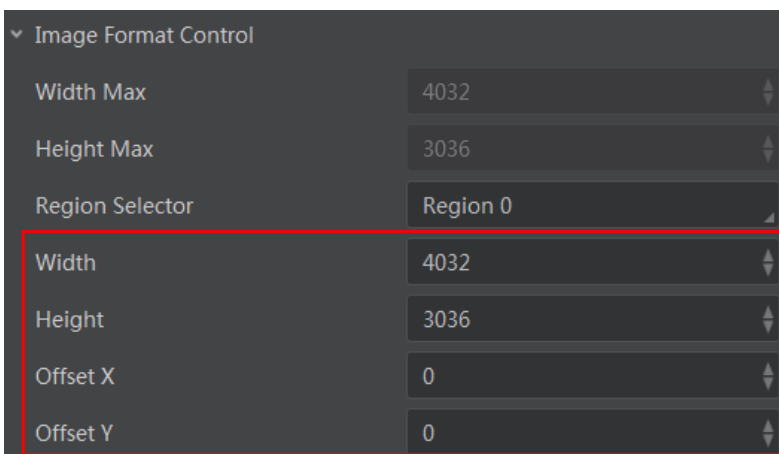

Figure 6-4 Set Region of Interest



 **NOTE**

Region of interest can be set only when you stop real-time acquisition.

## 6.2.4 Set Binning

The purpose of setting binning is to enhance sensibility. With binning, multiple sensor pixels are combined as a single pixel.

Usually, the binning modes used by the camera (vertical and horizontal) are preset and cannot be changed. However, for specific camera models and for specific binning directions, the binning mode can be set, as shown below.

**Steps:**

1. Click **Image Format Control**.
2. Select value in **Binning Horizontal** and **Binning Vertical**.

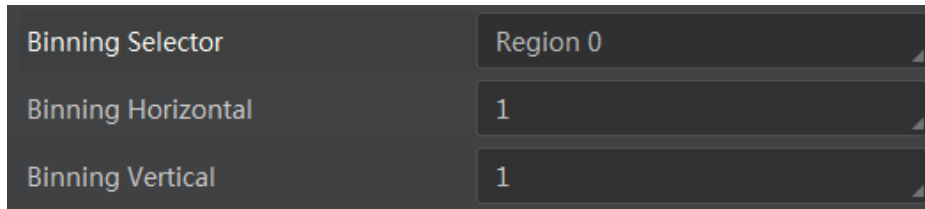

Figure 6-5 Set Binning

 **NOTE**

The different models of camera may have different binning function, and the actual device you purchased shall govern.

## 6.2.5 Set Decimation

The decimation feature allows you to reduce the number of sensor pixel columns or rows that are transmitted by the camera. This procedure is also known as "subsampling". It reduces the amount of data to be transferred and may increase the camera's frame rate.

**Steps:**

1. Click **Image Format Control**.
2. Select value in **Decimation Horizontal** and **Decimation Vertical**, as shown below.

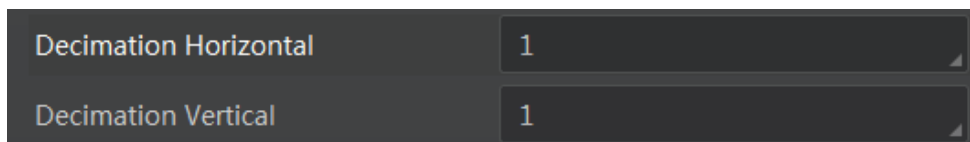

Figure 6-6 Set Decimation

**NOTE**

The different models of camera may have different decimation function, and the actual device you purchased shall govern.

## 6.3 Global Shutter and Rolling Shutter

### 6.3.1 Global Shutter

For cameras that support global shutter: exposure starts and ends in each line simultaneously. After the exposure, data readout starts line by line. All pixels expose at the same time, then readout at different time, as shown below.

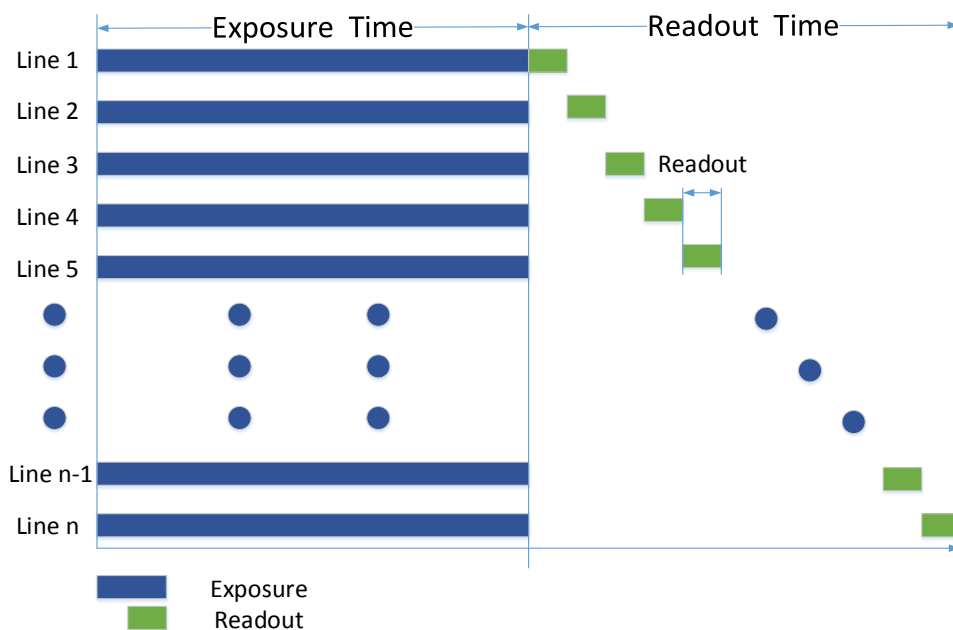

Figure 6-7 Global Shutter

- The figure of global shutter’s signal readout under internal trigger mode

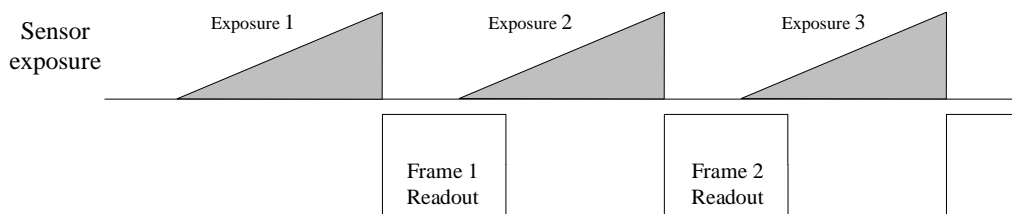

Figure 6-8 Signal Readout under Internal Trigger Mode

- The figure of global shutter’s signal readout under external trigger mode

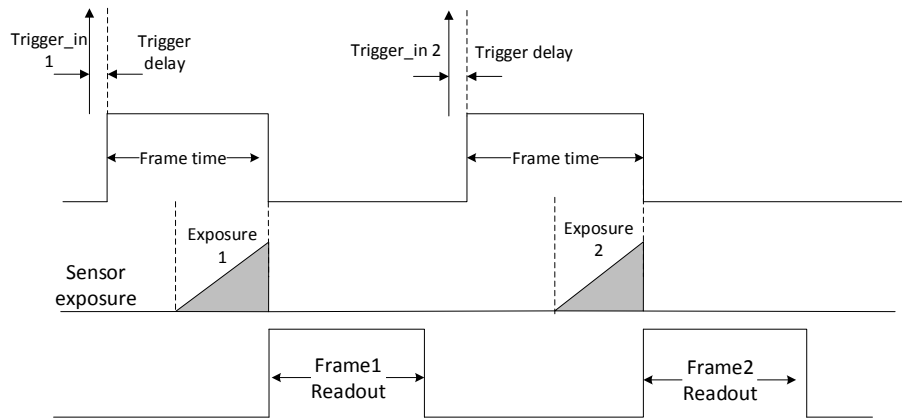

Figure 6-9 Signal Readout under External Trigger Mode

### 6.3.2 Rolling Shutter

For cameras that support rolling shutter: as soon as the exposure ends, and the data readout starts simultaneously. After the whole action, the rest of rows start to expose and read out one by one. All pixels expose at the same time, then readout at different time, as shown below.

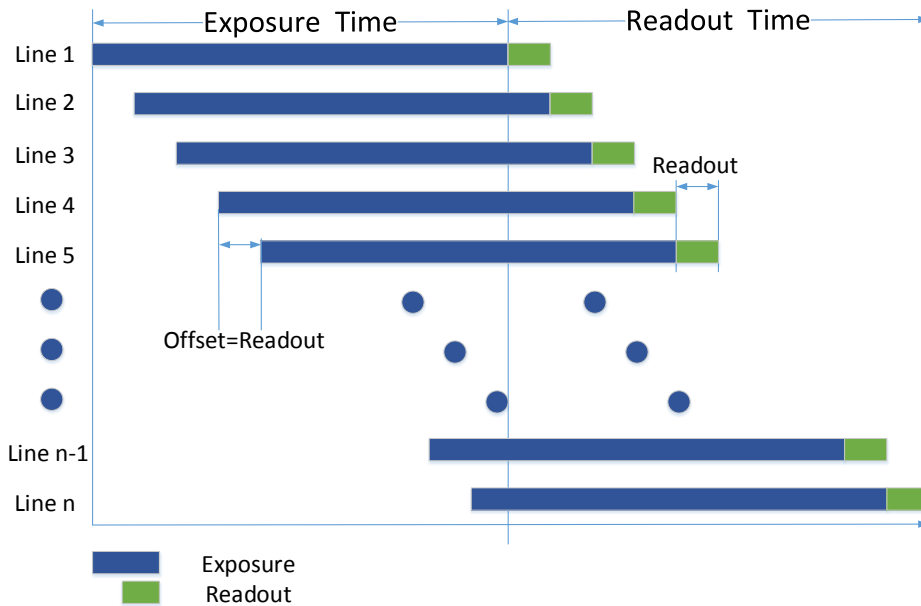

Figure 6-10 Rolling Shutter

The figure of rolling shutter's signal readout under internal trigger mode is the same with that of global shutter as shown in Figure 6-8, and the figure of rolling shutter's signal readout under the external trigger mode is the same with that of global shutter as shown in Figure 6-9.

## 6.4 Image Acquisition and Transmission

### 6.4.1 Set Acquisition Mode

The camera has two image acquisition modes, including continuous mode and single frame mode. Settings are listed as follows:

**Steps:**

1. Click **Acquisition Control**, set the **Acquisition Mode** as shown below.
2. Select **Continuous**, the camera output images at current frame rate continuously. Select **SingleFrame**, the camera output one single image.

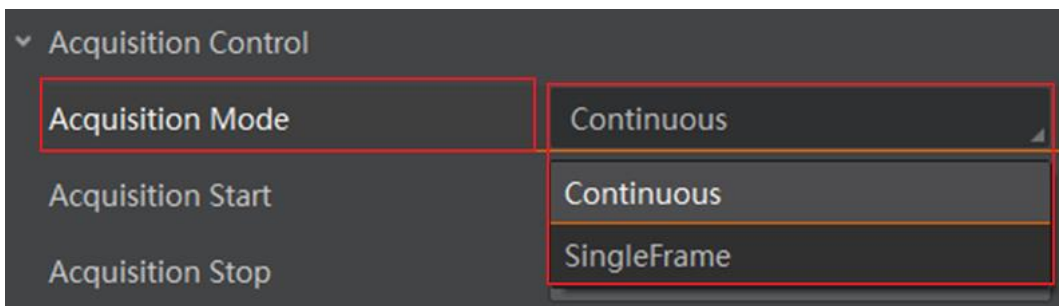

Figure 6-11 Set Acquisition Mode

### 6.4.2 Set Trigger Mode

The camera has two image trigger modes, including internal trigger mode and external trigger mode. Select **On** or **Off** in **Trigger Mode** to select either external trigger mode or internal trigger mode. **Off** refers to the internal trigger mode and **On** refers to the external trigger mode, as shown below.

**Steps:**

1. Click **Acquisition Control > Trigger Mode**.
2. Select **Off** or **On**.

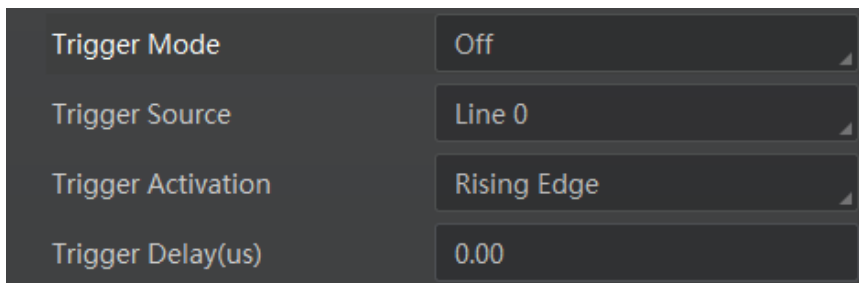

Figure 6-12 Set Trigger Mode

### 6.4.3 Set External Trigger and Work Mode

The signal for the camera to acquire external trigger includes the software trigger signal and the signal from external level. Under the external trigger signal mode, the camera can output images according to single frame acquisition, burst acquisition and other work modes.

The software trigger and hardware trigger of external trigger mode both support related parameters setting, including trigger delay, trigger cache and etc.

#### ● Trigger Delay

From camera receiving signal and responding, this period is trigger delay. It is set by the **Trigger Delay** in the client software, and the range is 0  $\mu$ s to 16000000  $\mu$ s.

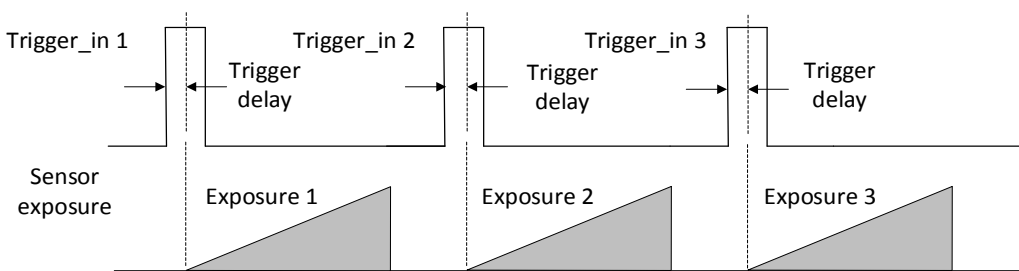

Figure 6-13 Signal Delay Sequence Diagram

#### ● Trigger Cache

During the triggering process, if the camera receives new trigger signal, it will save and process the signal. Trigger cache can save up to 2 trigger signals.

#### Steps:

1. Click **Acquisition Control > Trigger Cache Enable**.
2. Enable **Trigger Cache Enable**.

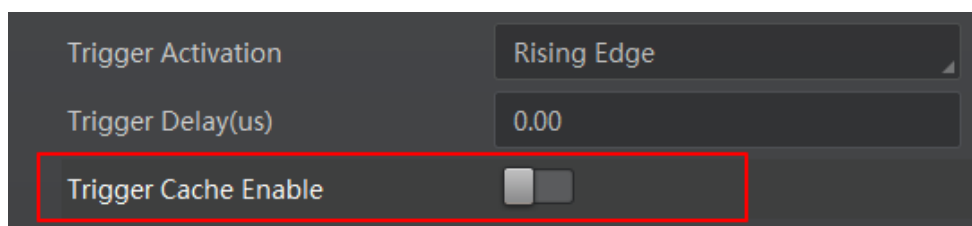

Figure 6-14 Set Trigger Cache

#### NOTE

If trigger cache function is disabled, the second trigger signal will be filtered when the first frame is exposing. If trigger cache function is enabled, the second trigger signal will be saved.

#### Software Trigger

The camera supports software trigger mode that triggers image acquisition and transmission via client software.

**Steps:**

1. Click **Acquisition Control > Trigger Mode**, select **On**.
2. Set **Software** as the trigger source, and click **Execute** as shown below.

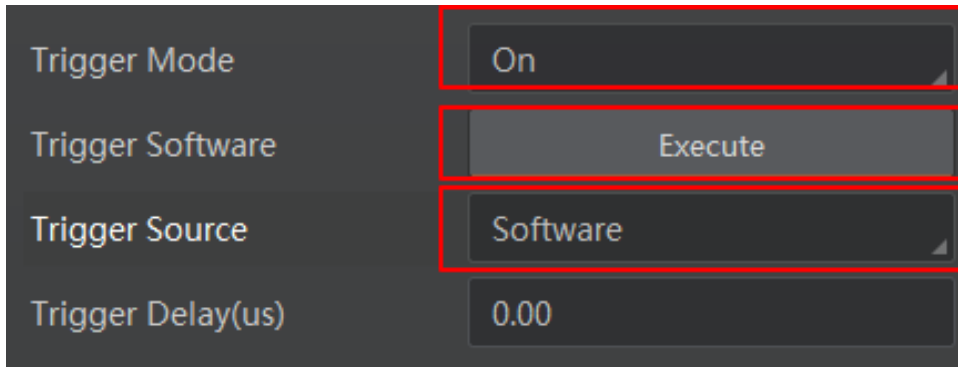

Figure 6-15 Set Software Trigger Mode

**Hardware Trigger**

Set the trigger source as the line No. of the external hardware to switch to hardware trigger.

**Steps:**

1. Click **Acquisition Control > Trigger Mode**, select **On**.
2. Set the line No. (for example **Line2**) as the trigger source to switch to hardware trigger.

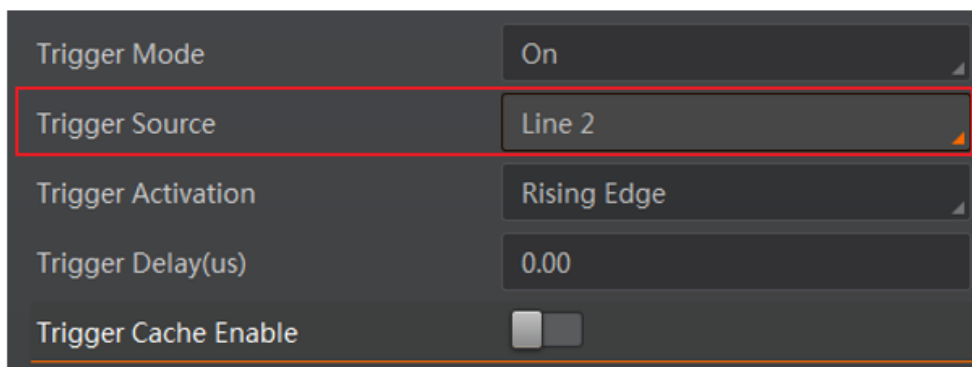

Figure 6-16 Set Hardware Trigger Mode

● **Trigger Activation**

In trigger activation, you can select falling edge or rising edge for external signal.

**Steps:**

1. Click **Acquisition Control > Trigger Activation**.
2. Select **Falling Edge** or **Rising Edge**, as shown below.

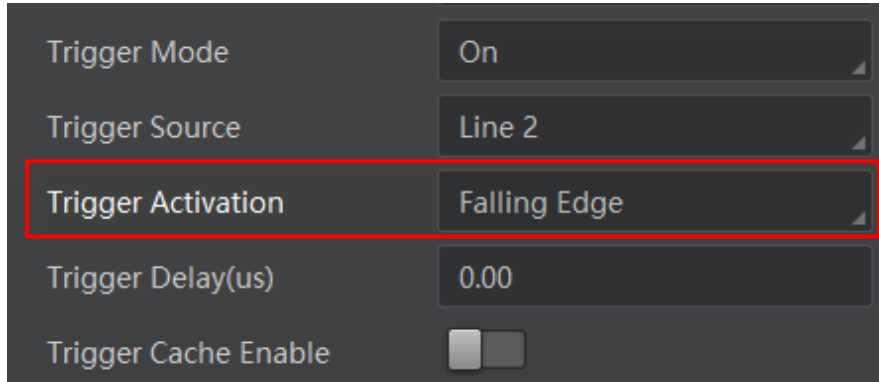

Figure 6-17 Set Trigger Activation

● **Trigger Debouncer**

Signal bouncer may cause false trigger, and it is suggested to debounce the external trigger signal. You can set debouncer parameter via client, and its sequence diagram is shown below.

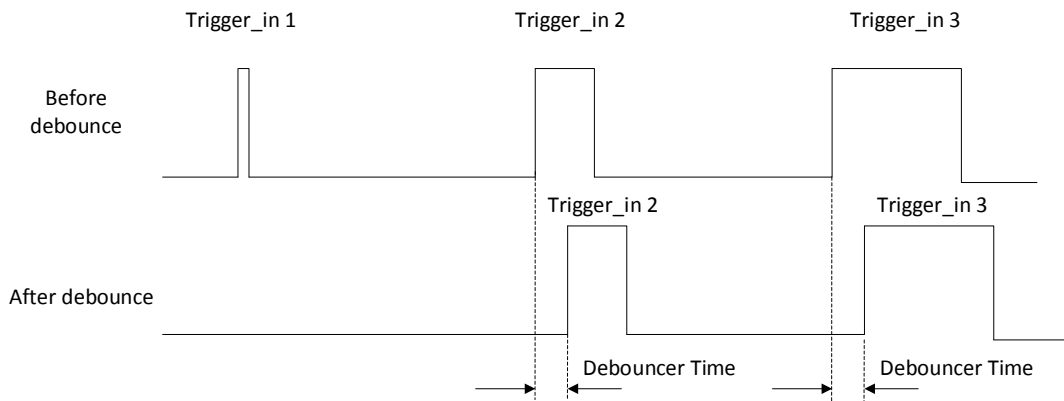

Figure 6-18 Debouncer of Triggering Input Signal

**Steps:**

1. Click **Digital IO Control > Line Debouncer Time**
2. Set value in **Line Debouncer Time**.

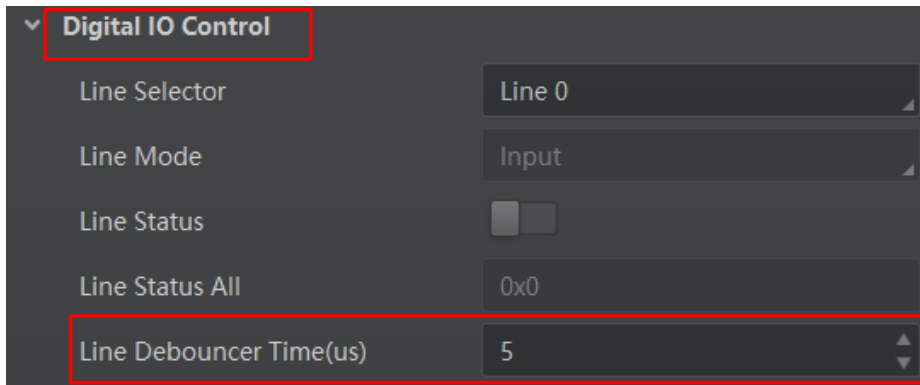

Figure 6-19 Set Debouncer Time

## 6.5 Set Strobe Output

Strobe is external output signal used to control external devices like flashlight.

### Steps:

1. Open the client software, click **Digital IO Control > Line Selector**, set it as the line No. of output.
2. Set the **Line Mode** as **Strobe** and enable the strobe as shown below.

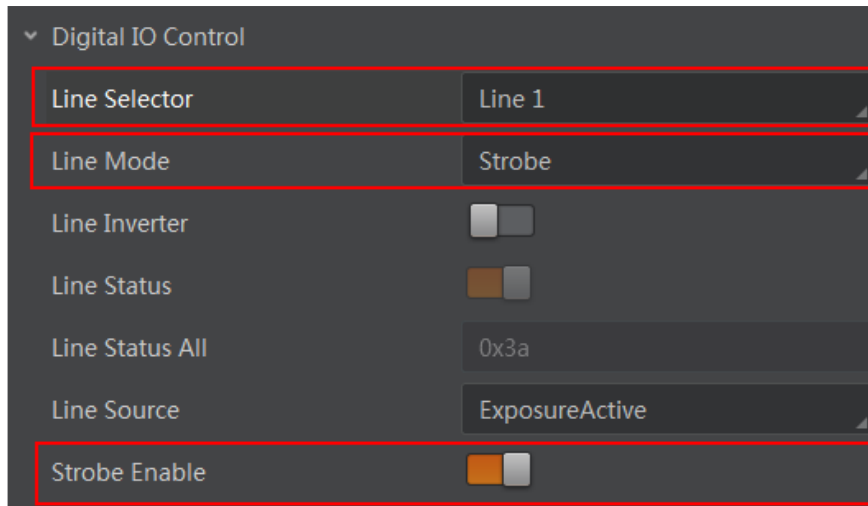

Figure 6-20 Set Strobe Output Mode

You can set the Strobe polarity, duration, output delay and other Strobe parameters through MVS client software.

### ● Strobe Polarity

Select **Line Inverter** to set the external trigger signal polarity as shown below.

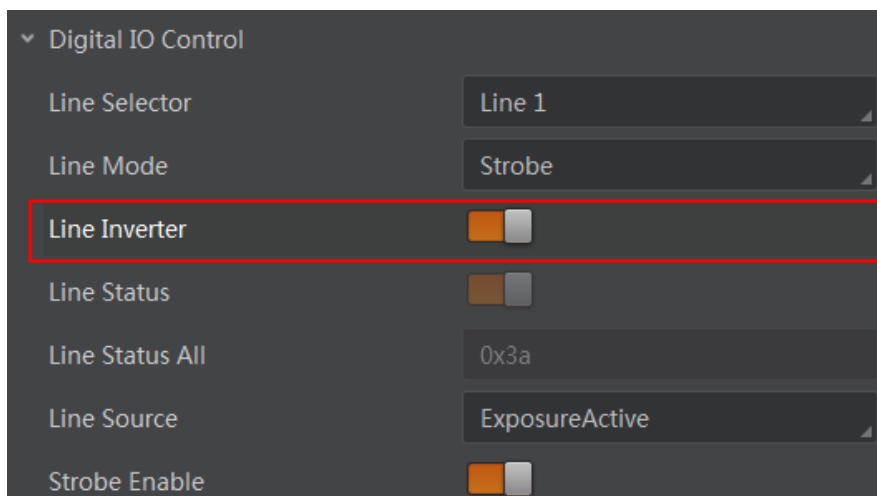

Figure 6-21 Set Strobe Polarity



● **Strobe Duration**

Strobe Line Duration value decides the Strobe duration: when the Strobe Line Duration value is 0, the Strobe duration is equal to the exposure time; when the Strobe Line Duration value is not 0, the Strobe duration is equal to Strobe Line Duration value.

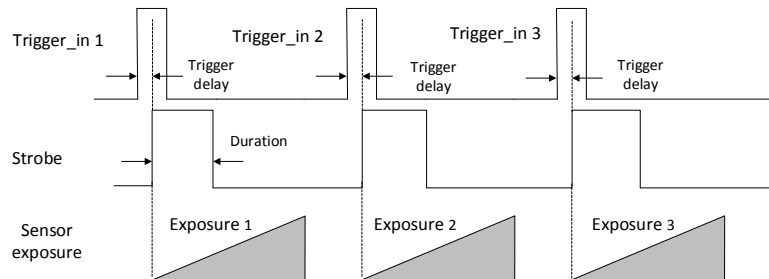

Figure 6-22 Strobe Duration Sequence Diagram

● **Strobe Output Delay**

The camera supports the function of Strobe signal output delay to meet user demands. When exposure starts, the Strobe output doesn't take effect immediately. Instead, the Strobe output will delay according to the setting in Strobe Line Delay.

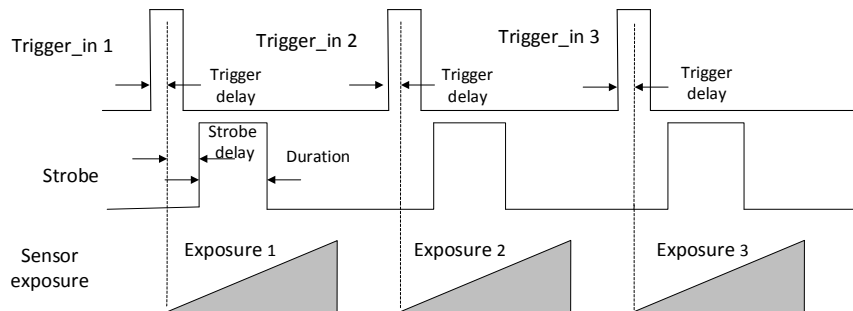

Figure 6-23 Strobe Output Delay Sequence Diagram

● **Strobe Pre-Output**

The camera also supports the function of Strobe pre-output. This function is applied to the flashing light that takes time to be stable after starting. It is necessary for a stable light source when capturing images. You can set pre-output time through Strobe Line Pre Delay in the client.

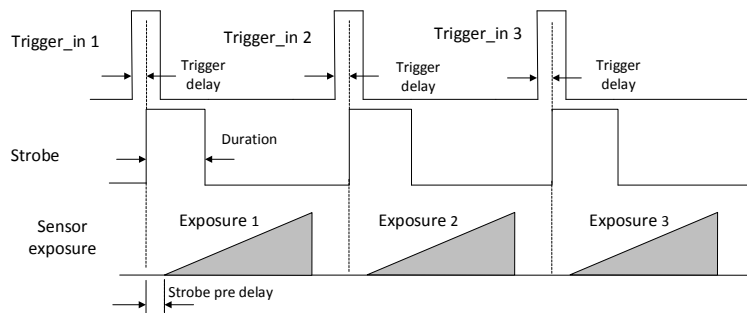

Figure 6-24 Strobe Pre-Output Sequence Diagram

**NOTE**

In fact, the Strobe pre-output function does not output strobe in advance, but delays exposure instead.

## 6.6 Acquisition Mode under External Trigger

The acquisition mode under external trigger includes single frame mode and burst mode. The relation among input trigger signal, Strobe output signal, camera exposure time and readout time under different modes is as follows:

### 6.6.1 Single Frame Mode

Under this mode, expose once only when inputting one trigger signal.

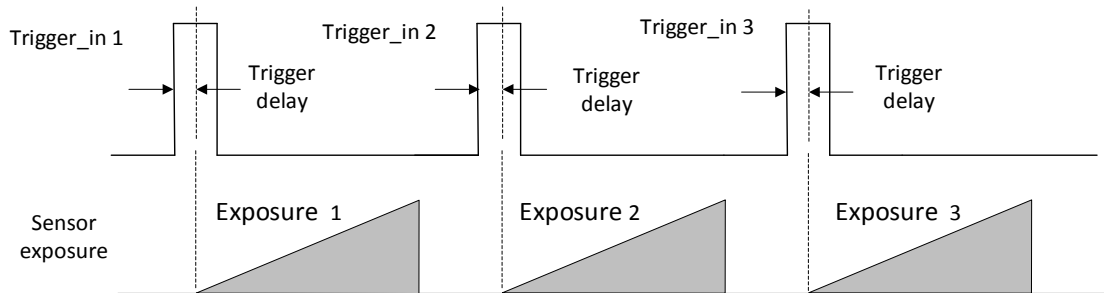

Figure 6-25 Single Frame Mode Sequence Diagram

During readout time of camera data, triggering the next frame or not depends on frame rate and exposure time. If exposure is in progress, the camera will ignore another external trigger signal. Under this mode, you can set a longer exposure time to achieve bulb shutter.

### 6.6.2 Burst Mode

The camera supports burst mode, which can receive one trigger signal and output multi-frame images. You can set the burst number by **Acquisition Burst Frame Count** in the client software, and the range is from 0 to 1023. If Burst Frame Count = 3, one trigger signal will output three-frame image. The sequence diagram of burst mode is shown below.

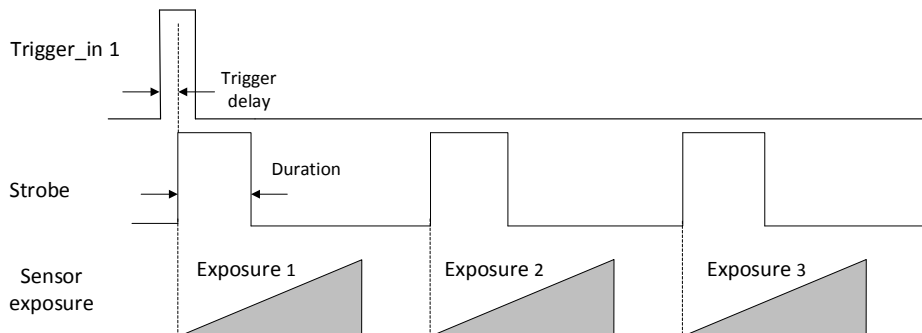

Figure 6-26 Burst Mode Sequence Diagram

## 6.7 Non-overlap Exposure and Overlap Exposure

The process that camera captures one frame of image includes two stages, exposure and readout. According to the overlap relation between the exposure time and the readout time, cameras with different sensors can be divided into overlap exposure and non-overlap exposure.

### 6.7.1 Non-overlap Exposure

After completing the current frame's exposure and readout, the next frame starts to expose and read out. This process is called non-overlap exposure. The non-overlap exposure's frame period is larger than the sum of the exposure time and the readout time, as shown below.

- **Non-overlap Exposure under Internal Trigger Mode**

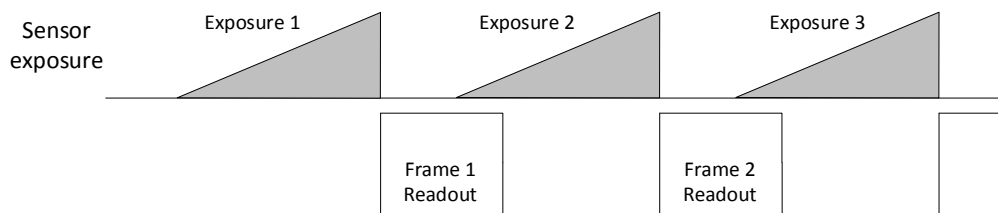

Figure 6-27 Internal Non-overlap Exposure

- **Non-overlap Exposure under External Trigger Mode**

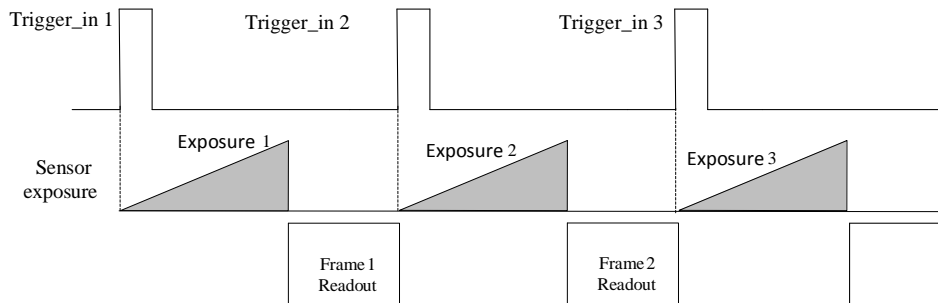

Figure 6-28 External Non-overlap Exposure

 **NOTE**

The camera will ignore the external signal in the readout section under this mode.

### 6.7.2 Overlap Exposure

Overlap exposure refers to the overlap between the current frame exposure and the previous frame readout. In other words, when the previous frame starts to read out, the current frame starts to expose simultaneously, as shown below.

- **Overlap Exposure under Internal Trigger Mode**

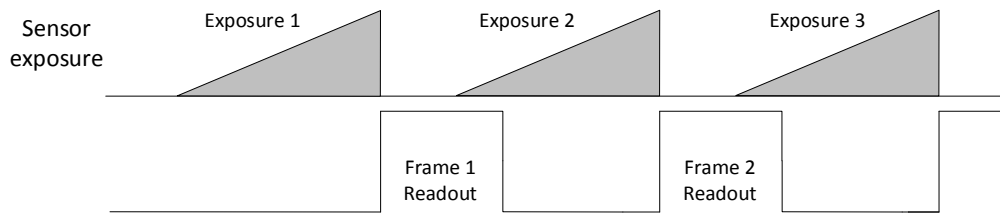

Figure 6-29 Internal Trigger Overlap Exposure

● **Overlap Exposure under External Trigger Mode**

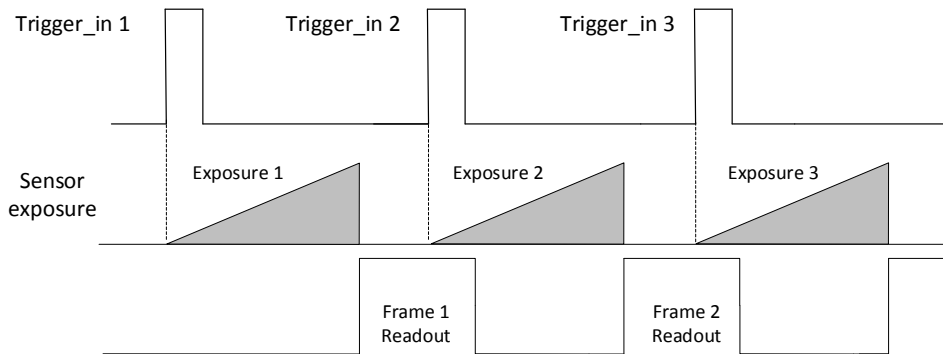

Figure 6-30 External Trigger Overlap Exposure

## 6.8 Counter and Timer Control

Counter provides frequency division to the external trigger signal. Settings are listed as follows:

**Steps:**

1. Click **Acquisition Burst Frame Count > Trigger Source**.
2. Set **Counter 0** as trigger source.

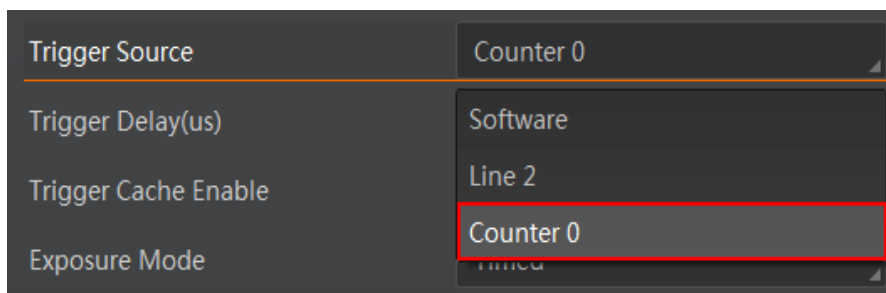

Figure 6-31 Set Trigger Source

3. Select the external signal source that needs frequency division under the **Counter And Timer Control > Counter Event Source** as shown below.

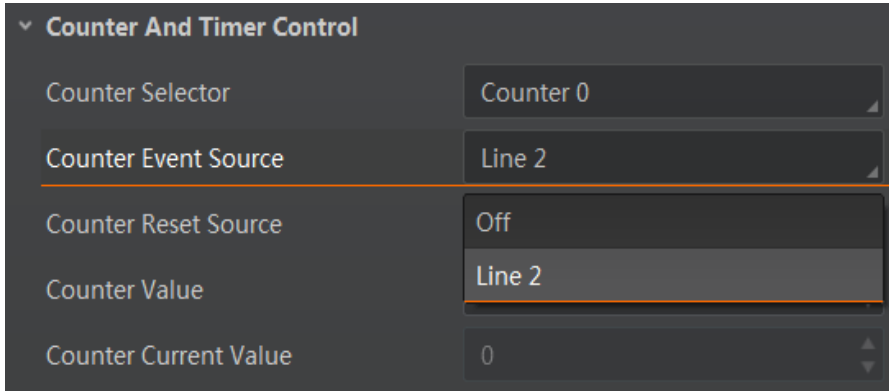

Figure 6-32 Counter Frequency Division

**NOTE**

Line 1 and Line2 can be configured as input or output. You can conduct frequency division for Line 1 and Line2 by setting them as input under **Digital IO Control** as shown below.

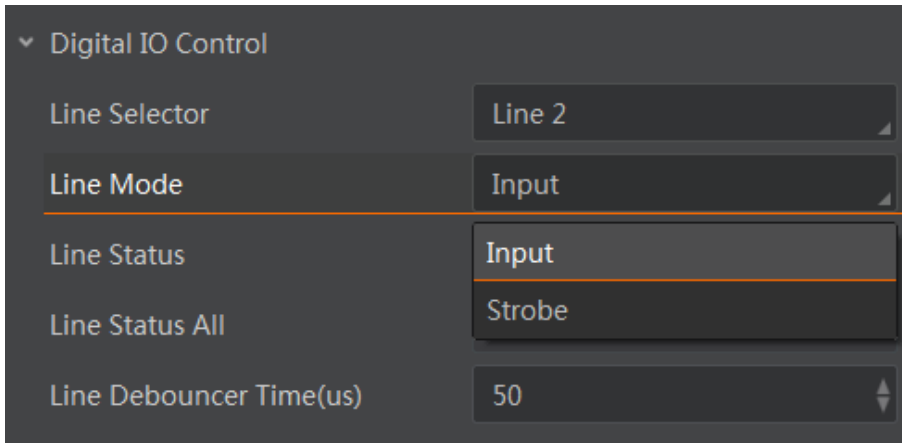

Figure 6-33 Set Line 2 as Input

4. Set the **Counter Value** under the **Counter And Timer Control** as shown below. Its range is from 1 to 1023.

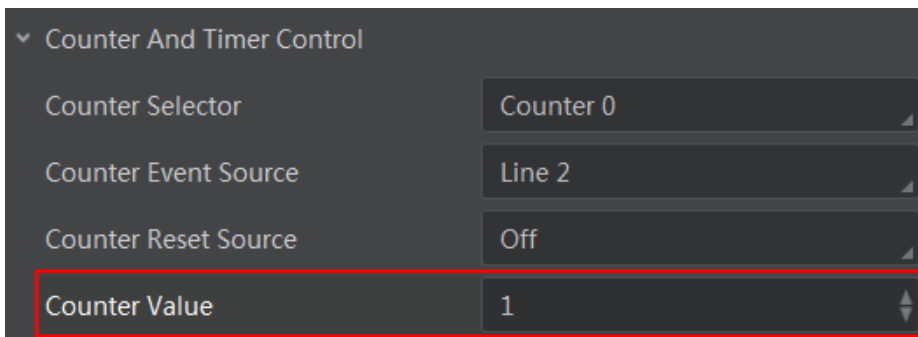

Figure 6-34 Set Counter Value

5. By default, **Counter Reset Source** is Off. You can reset counter by select **Software** as the **Counter Reset Source**, and click **Execute** to reset as shown below.

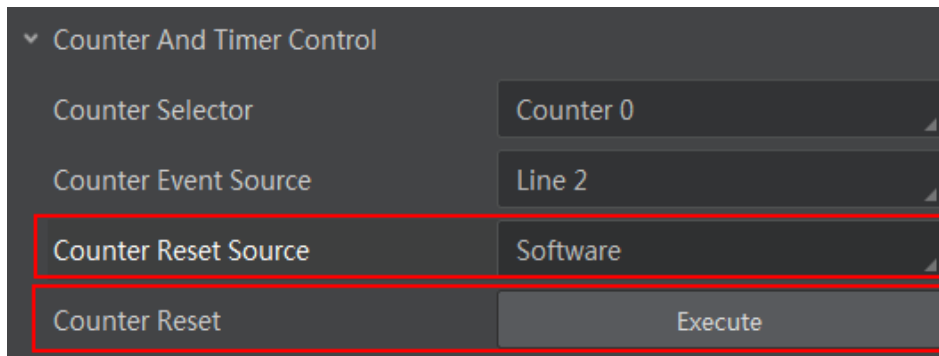

Figure 6-35 Reset Counter

## 6.9 Image Parameter Setting



Please refer to the Specifications of the camera which is available in [en.hikrobotics.com](http://en.hikrobotics.com) or the specific parameters.

### 6.9.1 Set Exposure Time

Exposure is the quantity of light or other radiation reaching a sensor, and it is determined by shutter speed and lens aperture. The camera supports three types of exposure modes: Off, Once and Continuous.

Please refer to the following table for details.

Table 6-2 Exposure Mode Description

Mode	Description
Off	The camera does not expose automatically.
Once	Adjust the exposure time automatically according to the image brightness. After adjusting, it will switch to Off Mode.
Continuous	Adjust the exposure time continuously according to the image brightness.

**Steps:**

1. Click **Acquisition Control** in the attribute list.
2. Select **Auto Exposure Time Lower Limit** and **Auto Exposure Time Upper Limit**.

3. Input valid parameter to the numeric field, and then auto exposure time operation parameter range setting is finished, as shown below.

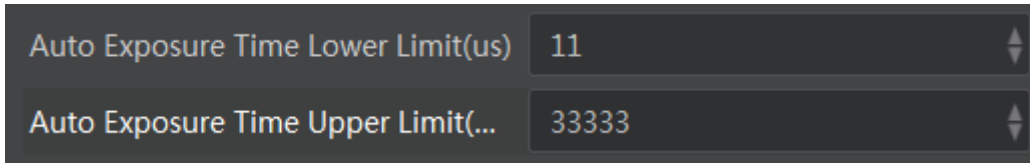

Figure 6-36 Set Exposure Control

 **NOTE**

The exposure time you want to set is bounded by the Auto Exposure Time Lower Limit and the Auto Exposure Time Upper Limit.

### 6.9.2 Set Gain

Gain is the increasing extent of the electric current, voltage, or power for the component, circuit, or system. The unit is dB. The larger the gain is, the brighter the image will be.

The camera supports three types of gain control: Off, Once and Continuous.

Table 6-3 Gain Control Description

Mode	Description
Off	Set Gain according to the user's setting value.
Once	Set Gain value automatically according to the target image brightness. Set once only.
Continuous	Set Gain value continuously according to the target image brightness.

 **NOTE**

When setting single mode or continuous mode, Gain is limited by Auto Gain Lower Limit and Auto Gain Upper Limit. Gain Range should only be set between Auto Gain Lower Limit and Auto Gain Upper Limit.

**Steps:**

1. Click **Analog Control** in the attribute list, click **Gain Auto**, and then select **Gain Mode**.
2. Input valid parameter in the numeric field and finish setting, as shown below.

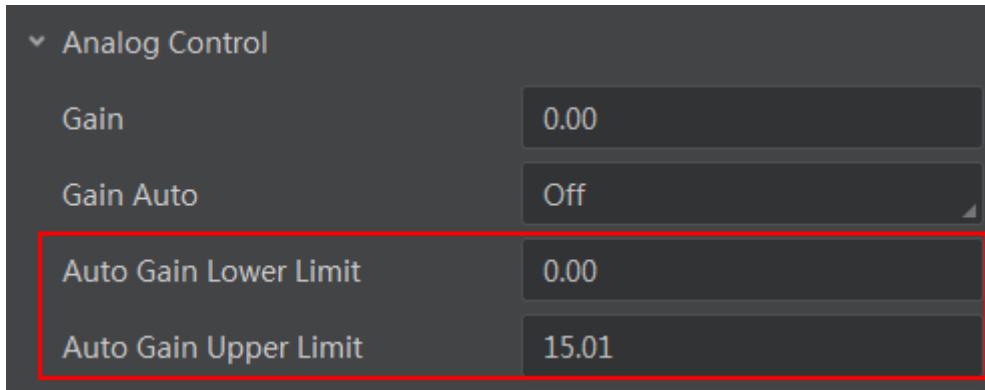

Figure 6-37 Set Gain Control

**NOTE**

Image noise will be amplified when the gain value is increased.

### 6.9.3 Set White Balance

White balance is the white rendition function of the camera used to adjust the color temperature according to the environment.

The white balance refers to the camera color adjustment depending on different light sources. Adjust the Gain Value of the image’s R channel and B channel to keep white regions white under different color temperatures. Ideally, the proportion of R channel, G channel and B channel in the white region is 1:1:1.

Table 6-4 White Balance Status Description

Status	Description
Off	You need to set the R, G, B value manually, between 1 and 4095. 1024 means ratio is 1.0
Once	Automatic white balance once. Adjust the white balance for a certain amount of time then stop. It implements an algorithm that finds possible gray areas in the Bayer data.
Continuous	Continuous automatic white balance. It implements an algorithm that finds possible gray areas in the Bayer data.

**NOTE**

White balance is only available on color cameras.

**Steps:**

1. Click **Analog Control** in the attribute list.
2. Select **Balance White Auto** and **Balance Ratio Selector**.



3. Select the mode and ratio, as shown below.

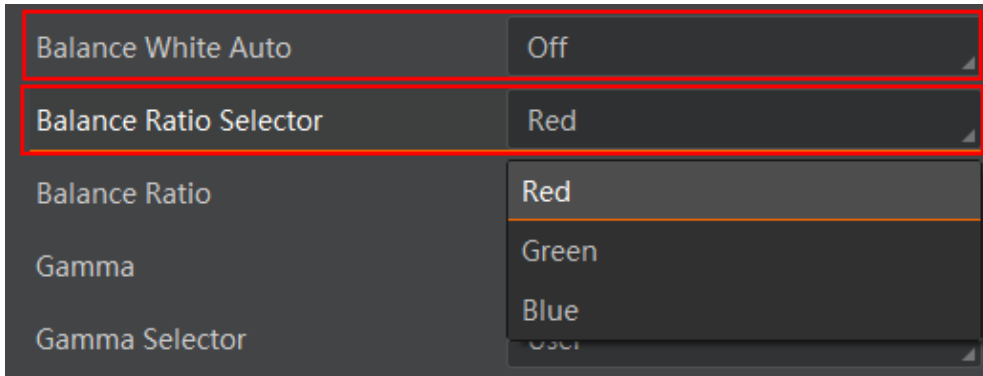

Figure 6-38 Set White Balance

### 6.9.4 Set Auto Function AOI

The camera adjusts exposure time and white balance automatically within a certain range to produce the quality of image you want. By default, the camera adjusts the brightness and white balance of the entire image.

- You can set regional exposure and regional white balance as desired. Regional exposure and regional white balance is normally used in areas where brightness differs greatly.
- You can also set an AOI and the camera will adjust the brightness and white balance of the entire image based on the area you select.

**Steps:**

1. Click **Analog Control**, and find **Auto Function AOI Selector**.
2. Select **AOI 1** or **AOI 2**, and adjust **Auto Function AOI Width** and **Auto Function AOI Height** as shown below.

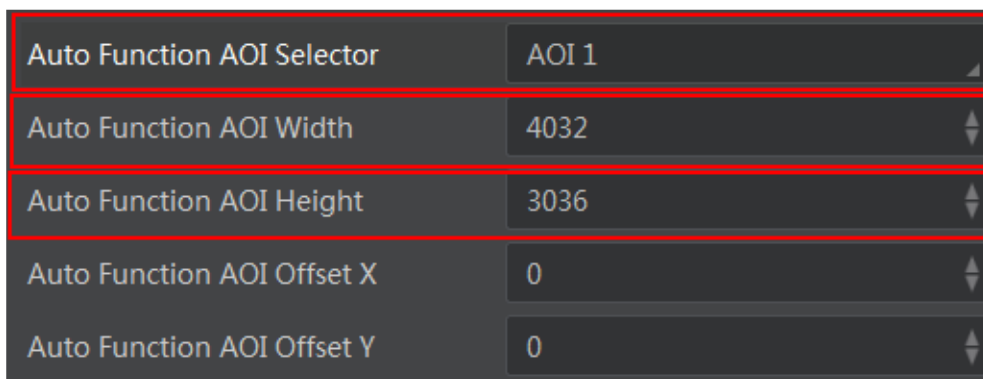

Figure 6-39 Set AOI

**NOTE**

- AOI 1 and AOI 2 are associated with shutter and white balance respectively. All cameras have AOI 1 function, but only color cameras have AOI 2 function.
- The effective regional exposure and regional white balance area is where AOI overlaps with the image. If there is no overlap, the effective area will be the entire image.

### 6.9.5 Set LUT

A Look-Up Table (LUT) is a customizable grayscale mapping table. You can stretch, amplify the grayscale range that interests you. The mapping can be linear or customized curve. You need to set user level to **Guru**, select **LUT Enable** true, then set value as shown below.

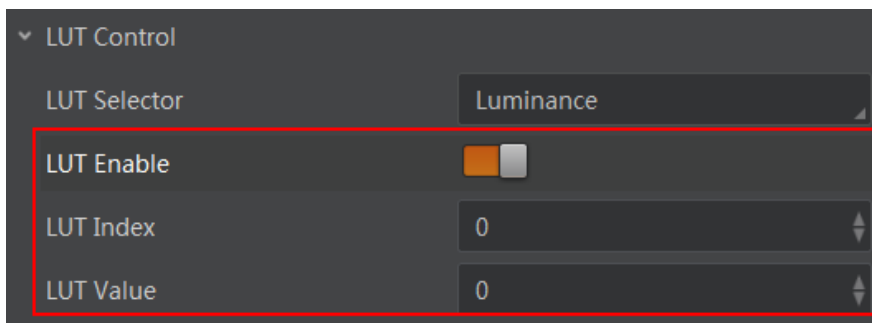

Figure 6-40 Set LUT

### 6.9.6 Set Gamma Correction

Generally, the camera sensor's output linearly relates to the quantity of photons shined upon the sensor. Gamma correction provides a non-linear mapping mechanism as shown below.

- Gamma value between 0.5-1: image brightness increases, dark area becomes brighter.
- Gamma value between 1-4: image brightness decreases, dark area becomes darker.

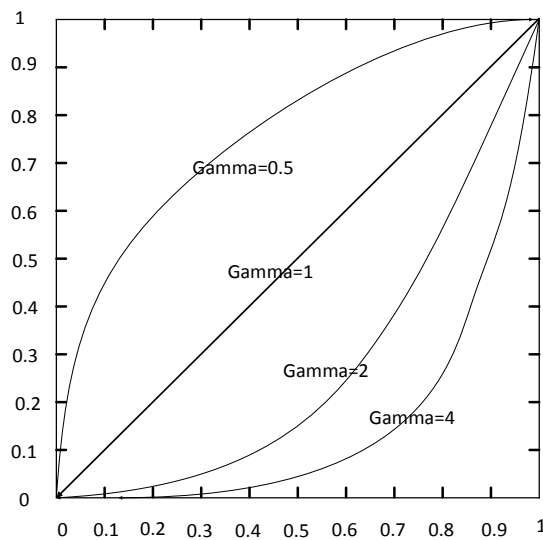

Figure 6-41 Gamma Curve

**Steps:**

1. Click **Analog Control**.
2. Find **Gamma** and **Gamma Selector**.
3. Set value as shown below.

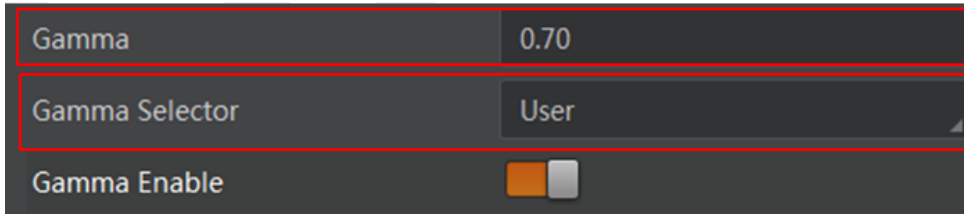

Figure 6-42 Set Gamma

 **NOTE**

Different camera versions have different default function parameters. The figures shown above are only for reference.

### 6.9.7 Set Brightness, Hue, Saturation and Sharpness

● **Brightness**

Brightness can be set when the camera is in auto exposure (Once, Continuous) mode or auto gain (Once, Continuous) mode. The default value is 64. The larger the value, the brighter the image. After setting Brightness, the system will automatically adjust exposure or gain to let image brightness reach the brightness of the target.

**Steps:**

1. Enable auto exposure (Once, Continuous) mode or auto gain (Once, Continuous) mode.
2. Click **Analog Control > Brightness**, and modify value, as shown below.

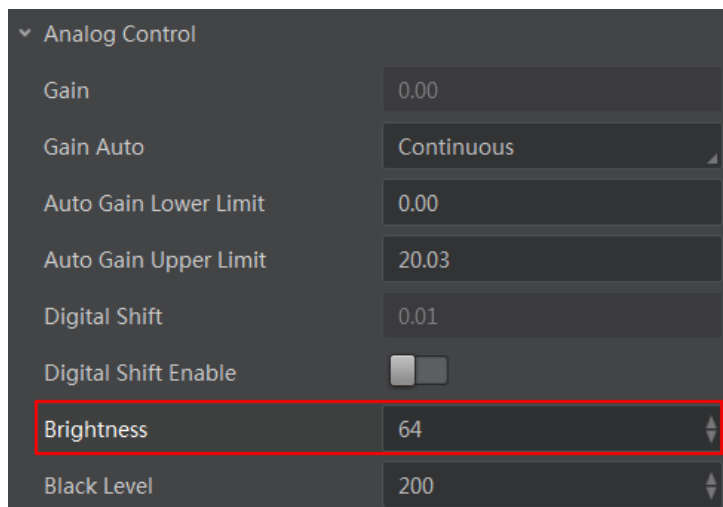

Figure 6-43 Set Brightness

- **Hue**

You can adjust the hue value in HSV. The default value is 128.

- **Saturation**

You can adjust the saturation value in HSV. The default value is 128. The larger the value, the higher the saturation and the stronger the color.

- **Sharpness**

You can adjust the sharpness value by enabling **Sharpness Enable** first, as shown below. The higher the sharpness, the more distinct the edge of the image object will be.

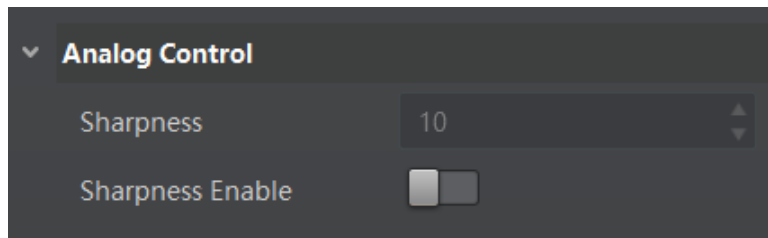

Figure 6-44 Set Sharpness

 **NOTE**

- The brightness function is available when only the camera is in auto exposure mode.
- The hue and the saturation are only for the color cameras.
- The sharpness function should be supported by the device.

### 6.9.8 Set Image Reverse

This function is available for the camera that supports image horizontal and vertical reverse.

**Steps:**

1. Click **Image Format Control**.
2. Check **Reverse X** (horizontal) or **Reverse Y** (vertical) according to your preference, as shown below.

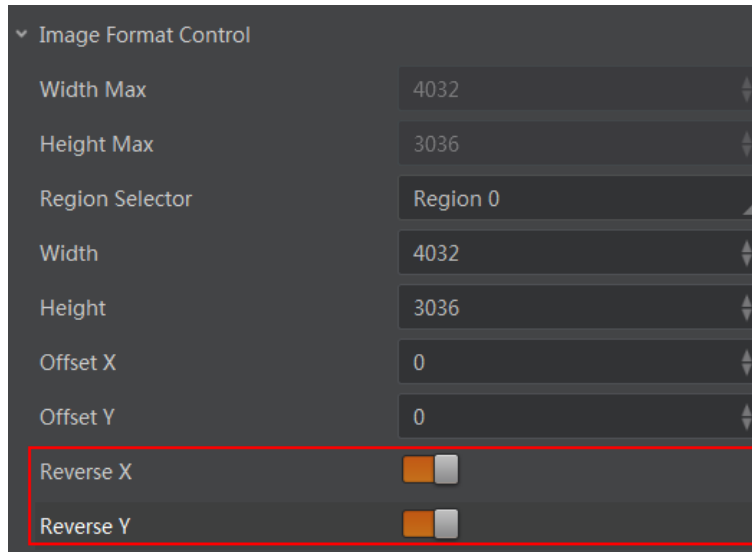

Figure 6-45 Reverse Function

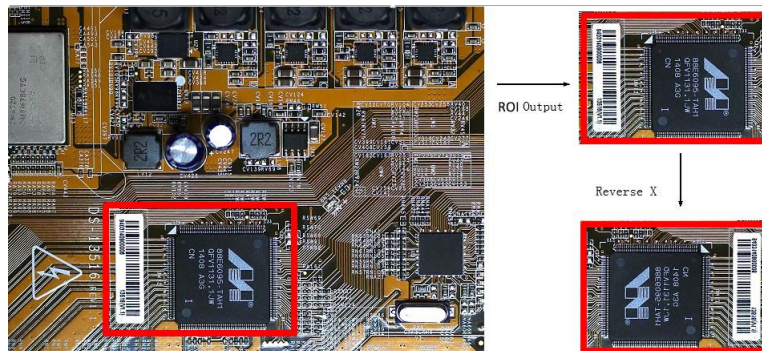

Figure 6-46 ROI Output Area Comparison

**NOTE**

Some models support image reverse function, the actual device you purchased shall govern.

### 6.9.9 Set HDR Polling

The camera supports HDR polling. In this mode, the camera acquires images based on four different sets of settings, each with its own exposure time and gain control. In **Acquisition Control**, find **HDR Selector**. Adjust the parameters for each set, set value in **HDR Shuter( $\mu$ s)**, and then enable **HDR Enable** as shown below.

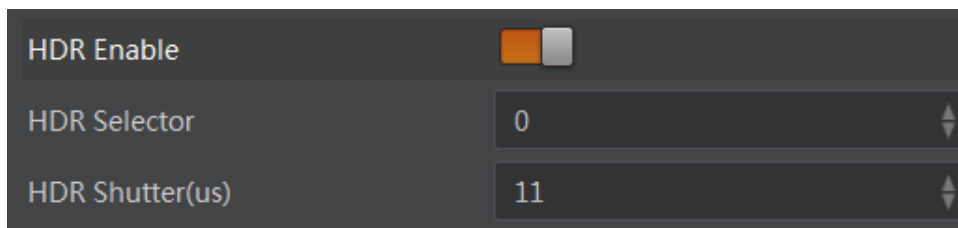

Figure 6-47 Set HDR

The polling of the four sets of HDR settings is shown below.

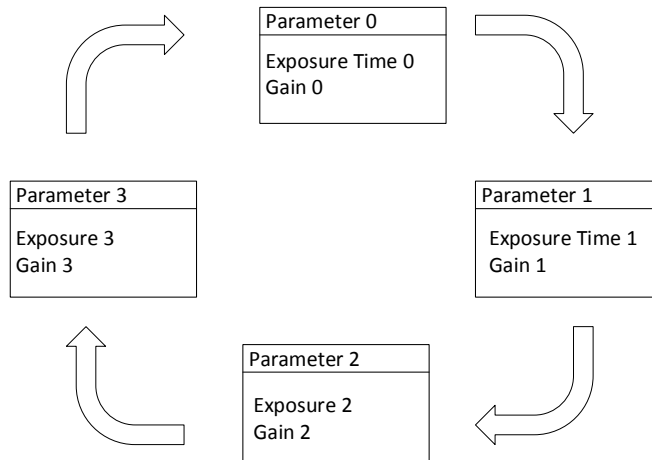

Figure 6-48 HDR Polling

**NOTE**

Some models support HDR polling function, and the actual device you purchased shall govern.

### 6.9.10 Set Test Mode

In client, click **Image Format Control**, find **Test Pattern** and set appropriate parameters. The default value is Off as shown below.

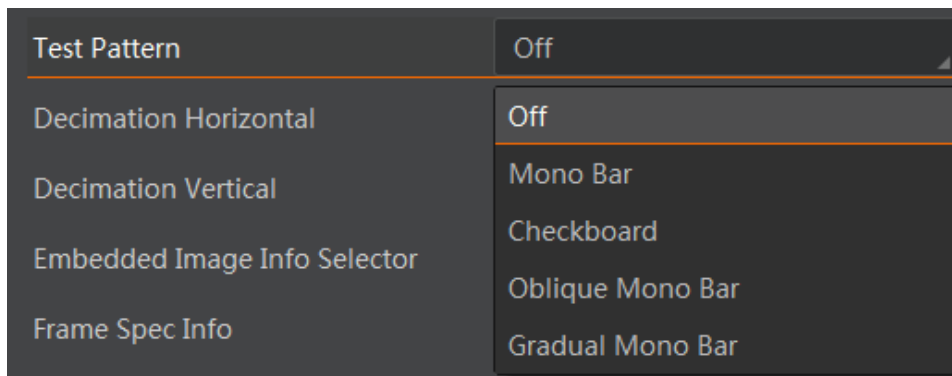

Figure 6-49 Set Test Mode

The camera offers six test patterns: Mono Bar, Checkboard, Oblique Mono Bar, Gradual Mono Bar, Vertical Color Bar and Horizontal Color Bar as shown in Figure 6-50, Figure 6-51, Figure 6-52, Figure 6-53, Figure 6-54, Figure 6-55.

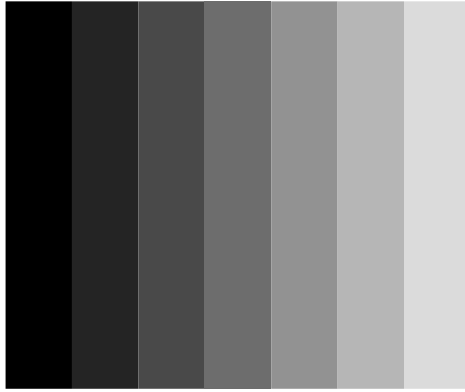

Figure 6-50 Mono Bar Test Pattern

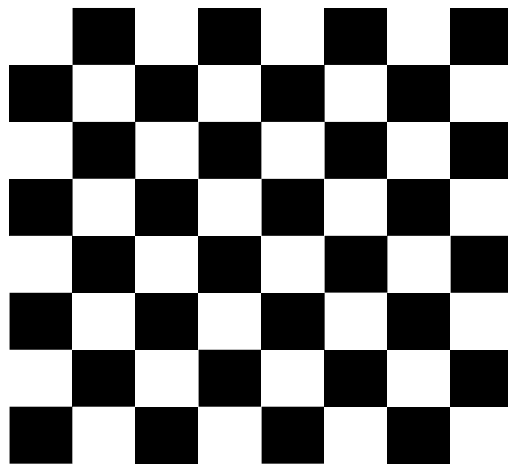

Figure 6-51 Checkboard Test Pattern

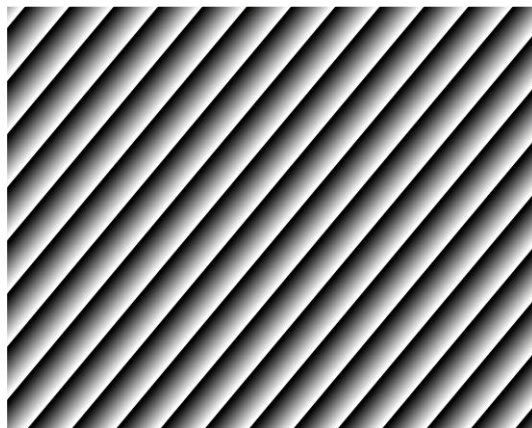

Figure 6-52 Oblique Mono Bar Test Pattern

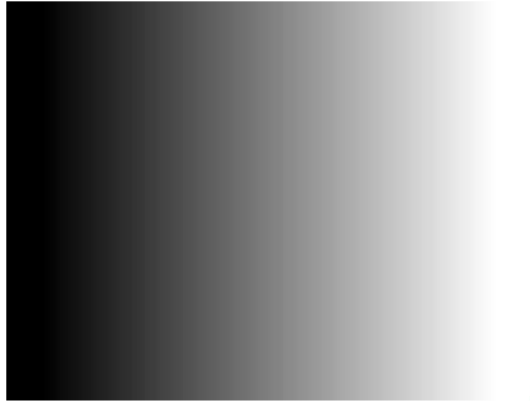

Figure 6-53 Gradual Mono Bar Test Pattern

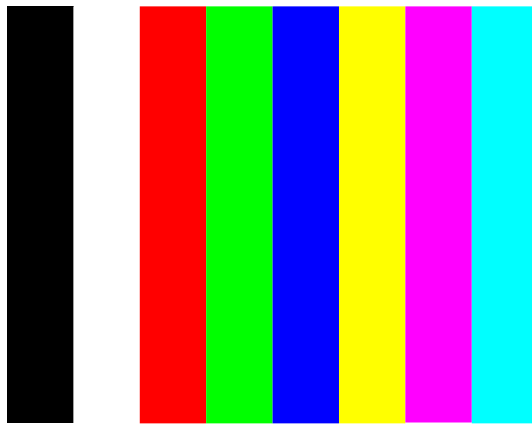

Figure 6-54 Vertical Color Bar Test Pattern

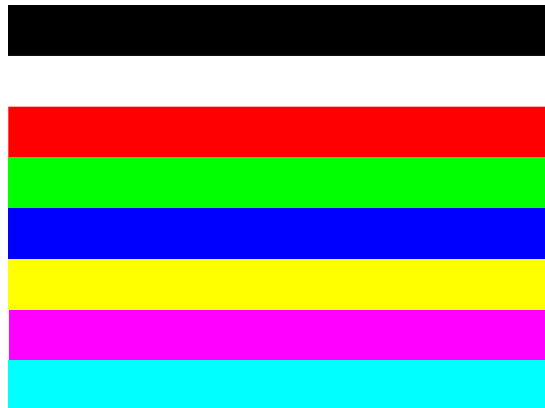

Figure 6-55 Horizontal Color Bar Test Pattern

 **NOTE**

The test modes that color camera and mono camera support are different, and please refer to your specific model for actual features.



### 6.9.11 Set Black Level

This function allows you to change the overall brightness of an image by changing the gray values of the pixels by a specified amount.

**Steps:**

1. Click **Analog Control > Black Level**.
2. Enable **Black Level Enable**.
3. Set value in **Black Level**, as shown below.

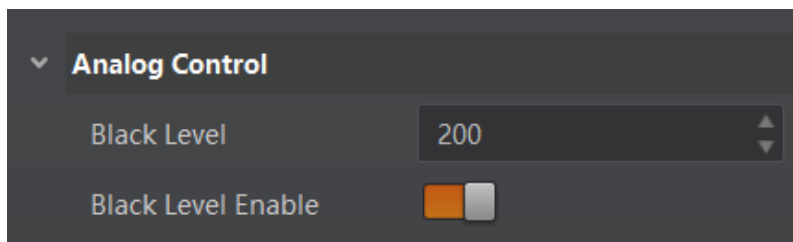

Figure 6-56 Set Black Level

### 6.9.12 Set Digital Shift

This function allows you to multiply the pixel values of the images, and it increases the brightness of the image.

**Steps:**

1. Click **Analog Control > Digital Shift**.
2. Enable **Digital Shift Enable**.
3. Set value in **Digital Shift**, as shown below.

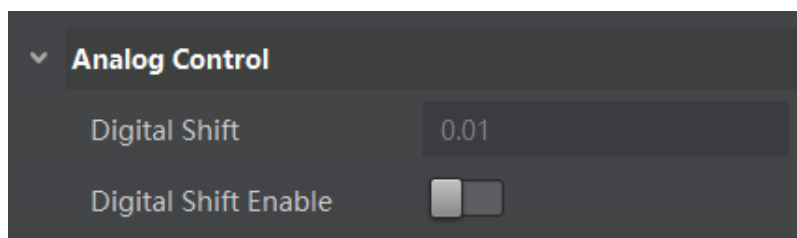

Figure 6-57 Set Digital Shift

### 6.9.13 Embedded Information in Image

The camera supports adding and embedding the collection information to the image data. You can set in the client software and define which information to be embedded in the image data.

Embedded information includes 8 categories: **Timestamp**, **Exposure Time**, **Frame Number**, **Alarm Input/Output**, **Gain**, **Brightness**, **Triggering Number**, and **ROI**.

Each category of embedded information has its unique data format.

Table 6-5 Embedded Information Data Format

No.	Information Type	Byte	Data Format Description
1	Timestamp	4 Bytes	4 bytes are used to transfer the timestamp information.
2	Gain	4 Bytes	4 bytes are used to transfer the gain information. Each low 8 bits of the 4 valid data are combined to transfer the gain information. Value Range: 0 to 1023. Note: High bits will be complemented with 0 automatically.
3	Exposure Time	4 Bytes	4 bytes are combined to show the exposure time, and the unit is $\mu\text{s}$ .
4	Brightness	4 Bytes	4 bytes are used to transfer the brightness information. Value Range: 0 to 4095. Note: High bits will be complemented with 0 automatically.
5	Frame Number	4 Bytes	Value Range: 0 to $2^{32}-1$ .
6	Trigger Number	4 Bytes	Value Range: 0 to $2^{32}-1$ .
7	ROI	8 Bytes	4 bytes stand for the start point, and 4 bytes stand for the length and width. In specific, the column coordinate occupies 2 bytes, and the row coordinate occupies 2 bytes. The column coordinate information comes first. In specific, the length and width occupy 2 bytes respectively, and the length information comes first.

You can set in the client software and define which information to be embedded in the image data. The camera supports adding the embedded information singularly, or in batch.

**Steps:**

1. Run MVS client software, and connect to the camera.
2. Click **Image Format Control > Embedded Image Info Selector**, and select parameters from drop-down list, as shown below.

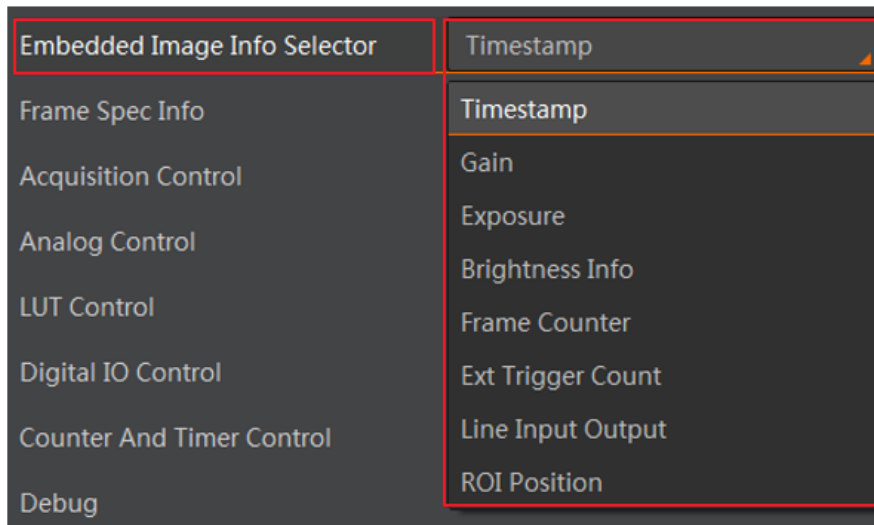

Figure 6-58 Embedded Information

## 6.10 I/O Electrical Feature and Wiring

### 6.10.1 I/O Electrical Feature

Line 1 and Line 2 can be configured as input and output in camera I/O control, and the I/O circuits are shown below.

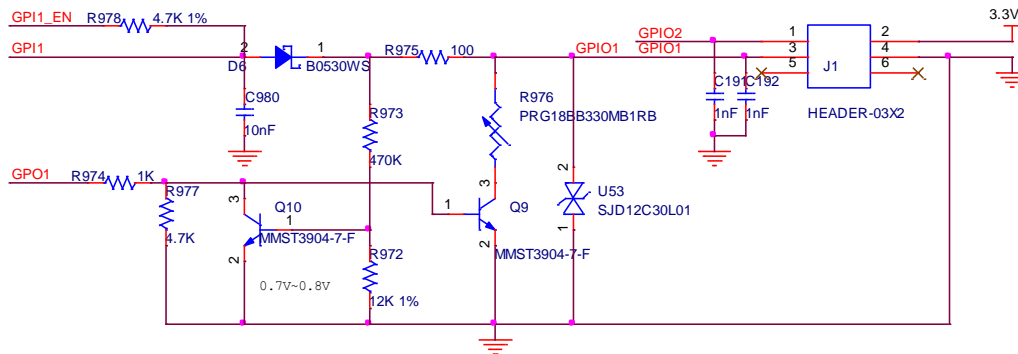

Figure 6-59 I/O Circuit (I)

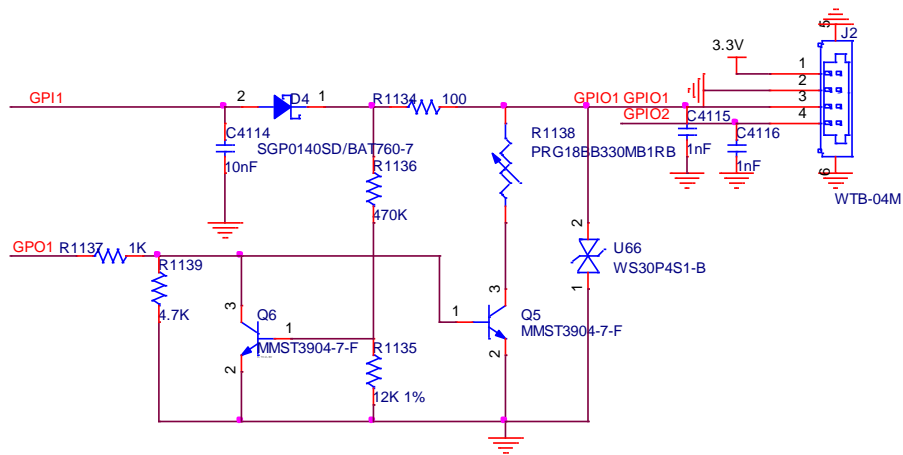

Figure 6-60 I/O Circuit (II)

**NOTE**

The I/O circuit of different models of camera may be different, and the actual device you purchased shall govern.

● **Line 1 and Line 2 Configured as Input**

Logic 0 input level: 0 VDC to 0.5 VDC (GPIO2 pin)

Logic 1 input level: 1.5 VDC to 30 VDC (GPIO2 pin)

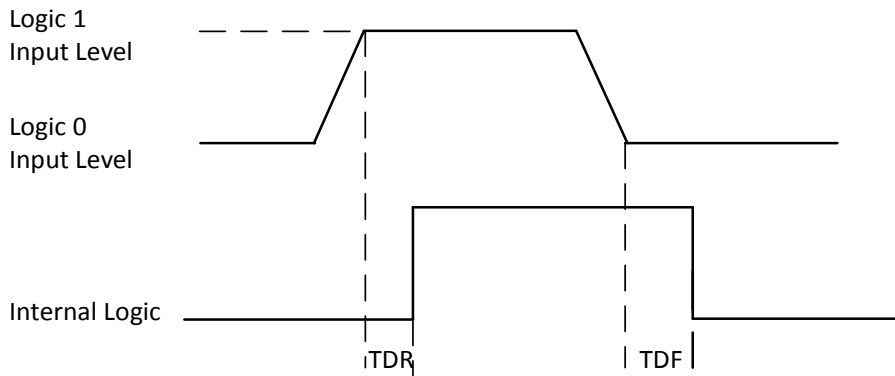

Figure 6-61 Input Logic Level

Input rising delay (TDR): 0.66  $\mu$ s

Input falling delay (TDF): 0.05  $\mu$ s

**NOTE**

To prevent damage to the GPIO pin, please connect GND first and then input voltage in Line 2 pin.

● **Line 1 and Line 2 Configured as Output**

The maximum current is 25 mA and the output impedance is 400  $\Omega$ .

When the environment temperature is 25 °C (77 °F), the relationship among external voltage, resistance and the output low level is shown below.

Table 6-6 Parameter of Output Logic Low Level

External Voltage	External Resistance	VL (GPIO2)
3.3 V	1 KΩ	160 mV
5 V	1 KΩ	220 mV
12 V	1 KΩ	460 mV
24 V	1 KΩ	860 mV
30 V	1 KΩ	970 mV

When the voltage of external resistance (1KΩ) is pulled up to 5V, the GPIO2 is configured as output logical level and the electrical features, as shown below.

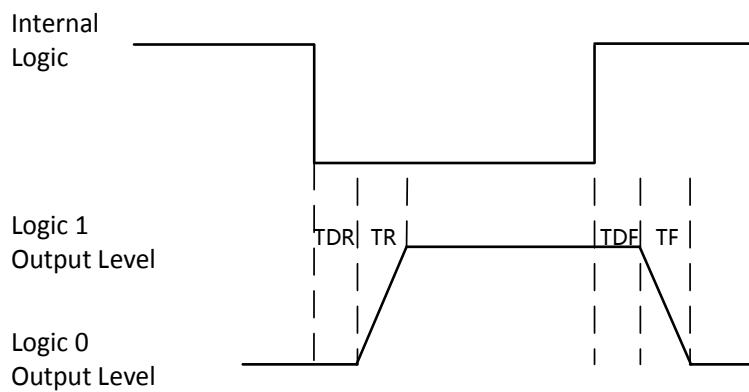

Figure 6-62 Output Logic Level

Table 6-7 Output Electric Feature

Parameter	Symbol	Value
Output Rising Time	TR	0.06 μs
Output Falling Time	TF	0.016 μs
Output Rising Delay	TDR	0.03 μs
Output Falling Delay	TDF	0.28 μs

## 6.10.2 I/O Wiring

Line 1 and Line 2 bi-direction I/O can be used as both input signal and output signal.

### Line 1 and Line 2 Configured as Input

When the camera uses Line1 and Line2 as hardware trigger source, wirings are different with different external devices of input signal.

- PNP Device

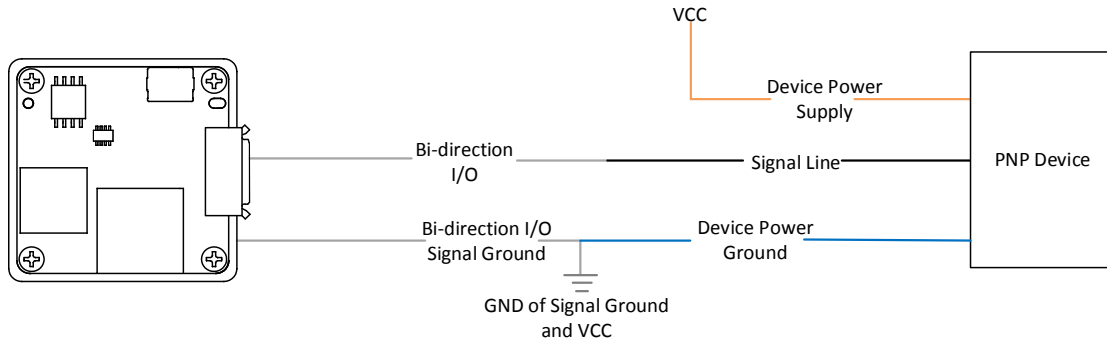

Figure 6-63 Line 1 and Line 2 Connecting to PNP Device as Input

- NPN Device

If the VCC of NPN device is 24 VDC, and it is recommended to use 1 K $\Omega$  to 4.7 K $\Omega$  pull-up resistor.

If the VCC of NPN device is 12 VDC, and it is recommended to use 1 K $\Omega$  pull-up resistor.

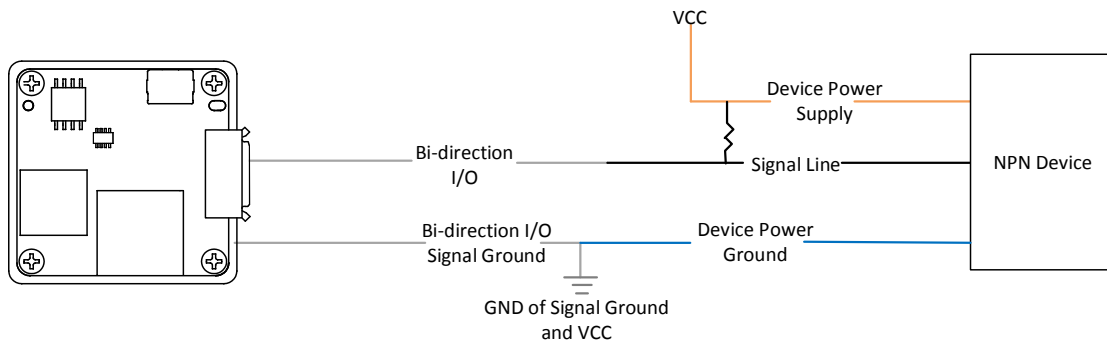

Figure 6-64 Line 1 and Line 2 Connecting to NPN Device as Input

- Switch

The switch value can provide low electrical level to trigger line 1 and line 2.

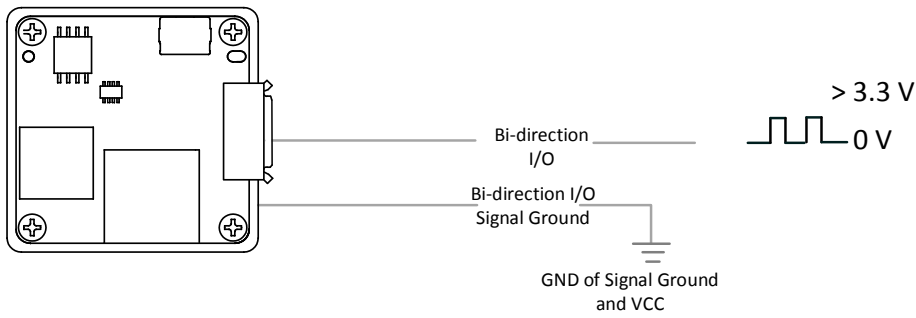

Figure 6-65 Line 1 and Line 2 Connecting to Switch as Input

**Line 1 and Line 2 Configured as Output**

When the camera uses Line 1 and Line 2 as output signal, wirings are different with different external devices.

- PNP Device

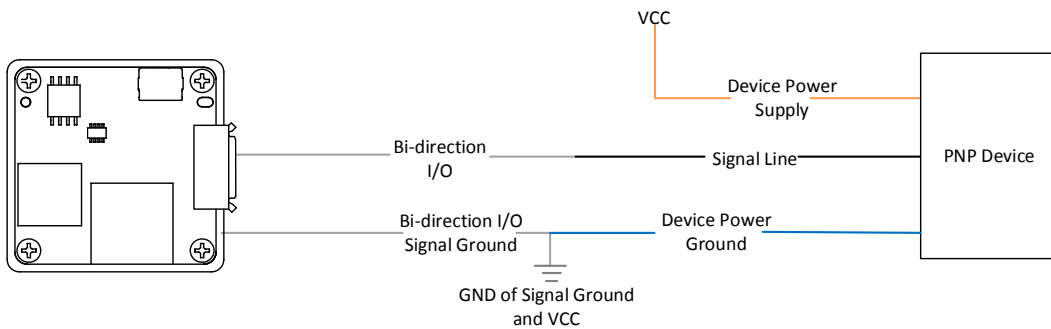

Figure 6-66 Line 1 and Line 2 Connecting to PNP Device as Output

- NPN Device

If the VCC of NPN device is 24 VDC, and it is recommended to use 1 KΩ to 4.7 KΩ pull-up resistor.

If the VCC of NPN device is 12 VDC, and it is recommended to use 1 KΩ pull-up resistor.

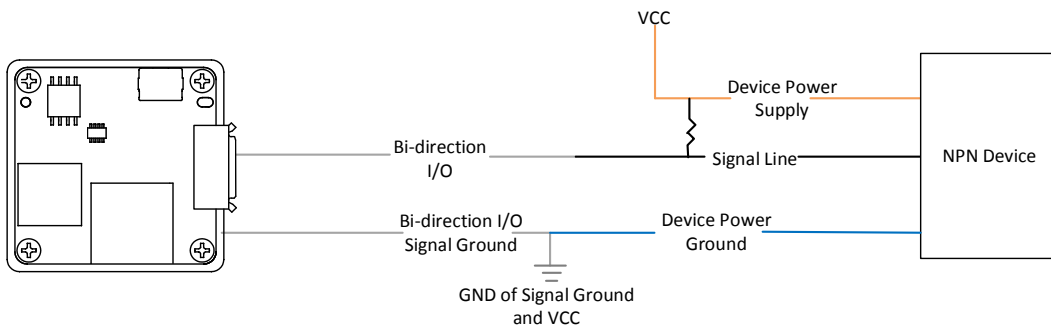

Figure 6-67 Line 1 and Line 2 Connecting to NPN Device as Output

 **NOTE**

For specific interfaces in back side of board level camera, the actual device you purchased shall govern.

## 6.11 Parameter Set Customization

### 6.11.1 Save and Load User Set

You can use **User Set Control** to define camera parameters that you might reuse in camera operations. The camera supports saving up to 4 sets of parameters: 1 factory set and 3 custom sets, as shown below. Custom parameter set will take effect after you save it and load it to the camera.

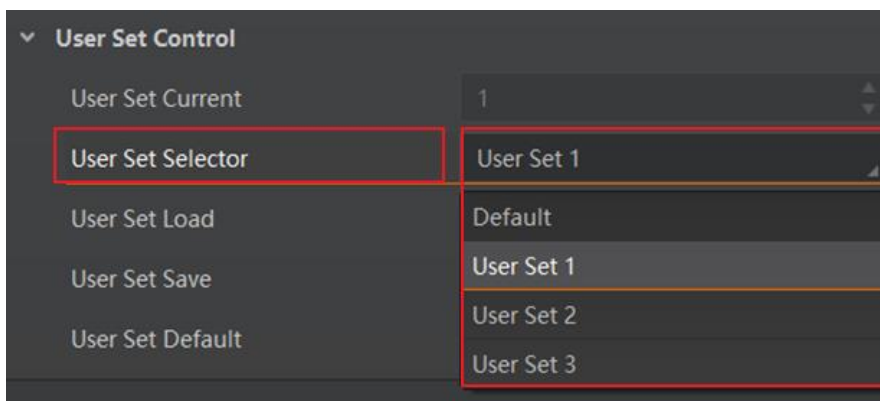

Figure 6-68 User Set Selector

 **NOTE**

Save the custom parameters set and select it as the default one, otherwise the camera adopts the factory set every time after being rebooted.

- **Save Parameters**

**Steps:**

1. Click **User Set Control**, and select a user set in **User Set Selector**. For example, select **User Set 1**.
2. Click **Execute** in **User Set Save** to save parameters.



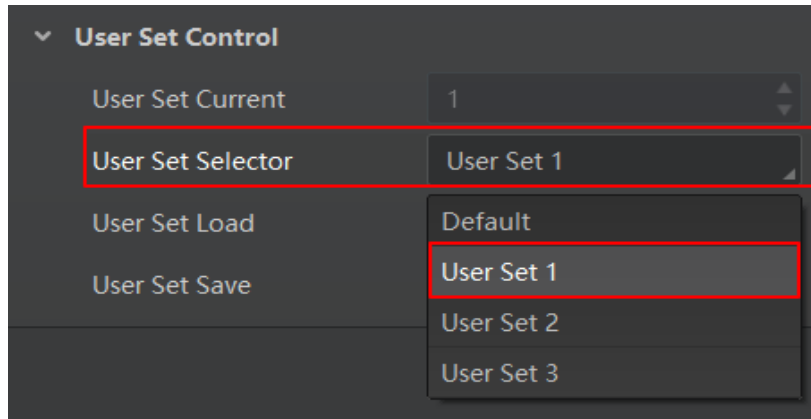

Figure 6-69 Select User Set

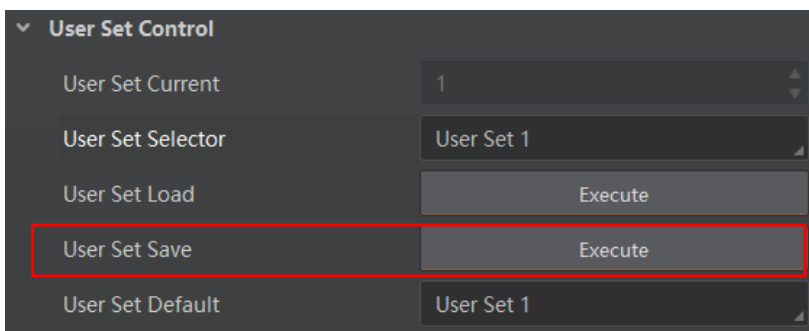

Figure 6-70 Save User Set

● **Load Parameters**

**Steps:**

1. Click **User Set Control**, and select a user set in **User Set Selector**. For example, select **User Set 1**.
2. Click **Execute** in **User Set Load** to load parameters to the camera, as shown below.

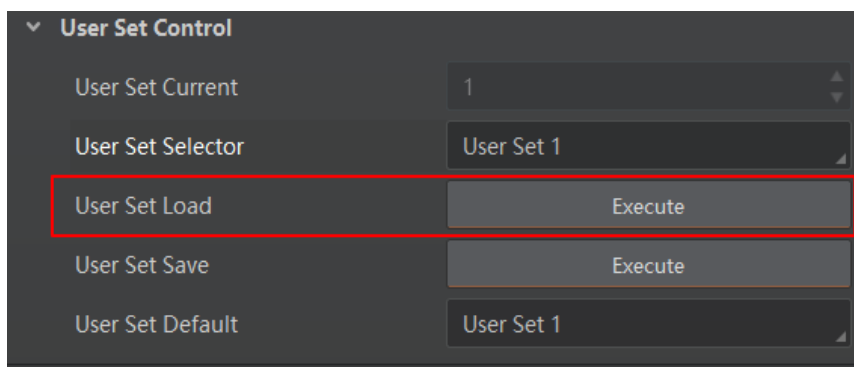

Figure 6-71 Load User Set

● **Set User Default**

You can also set default parameter by selecting **User Set** parameter in **User Set Default** as shown below.

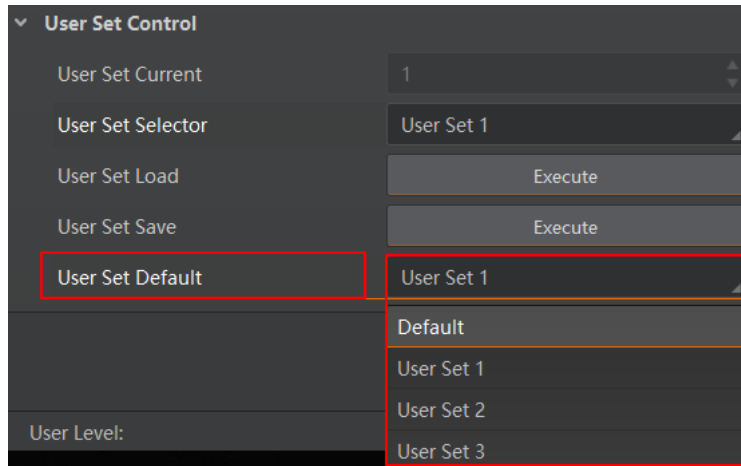

Figure 6-72 Set User Default

**NOTE**

- **User Set Current** item refers to the current working parameters set.
- After you load parameters of the user set into the camera, the value for the **User Set Current** item will be changed to the corresponding number.
- 0 stands for the default factory set, 1 stands for the user set 1, 2 stands for the user set 2, and 3 stands for the user set 3.

The relation among 4 sets of parameters is shown below.

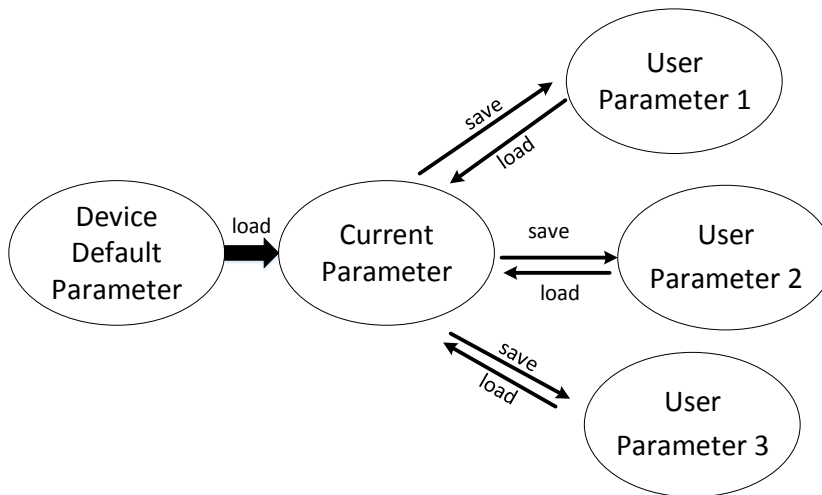

Figure 6-73 Parameter Relation



## 6.12 Firmware Update

The camera supports firmware update via the MVS client, and you can update the firmware of the camera via the Firmware Updater.

 **NOTE**

- Before updating, make sure power cable and others are properly connected.
- You should stop the live view and disconnect the camera before updating the firmware.
- Cameras of different types of interfaces cannot be updated at the same time.
- Please use the firmware package of the corresponding camera model for updating.

**Steps:**

1. Run MVS client software, and click **Tool > Firmware Updater** to open the update interface.
2. Click  to select the camera.
3. Click  to select the update file in the local PC.
4. Click **Upgrade** to start updating.

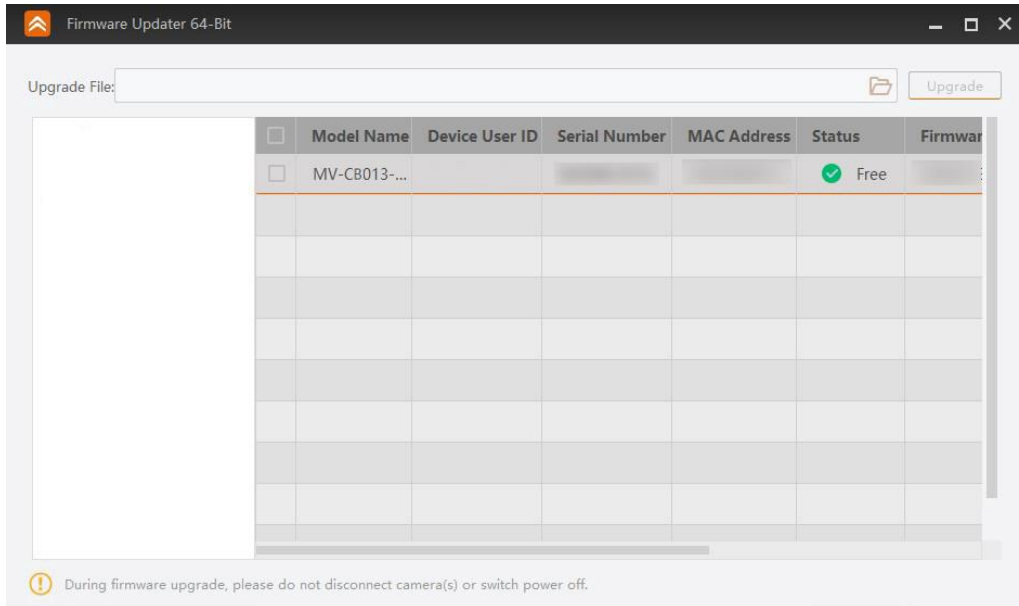

Figure 6-74 Update Firmware

 **NOTE**

You can only update the firmware when the camera is free, and rebooting is required after updating the camera.

## Chapter 7 Trouble Shooting

Table 7-1 Trouble Shooting

No	Trouble	Possible Reason	Solution
1	<p>1. No camera found when opening the client.</p> <p>2. Camera connection error.</p>	<p>1. Camera is not started up normally, or USB cable connection error.</p> <p>2. MVS client or USB3.0 driver is not normally installed.</p>	<p>1. Check camera power wiring (observe the LED indicator), and check cable connection.</p> <p>2. Check driver installation.</p> <p>3. Reinstall MVS client or USB3.0 driver.</p>
2	Live view is black.	Aperture is closed, or camera error.	Open the aperture or reboot the camera.
3	Live view is normal, but camera cannot be triggered.	Incorrect wiring or trigger mode is not enabled.	<p>1. Check whether the camera trigger mode and related trigger signal input are normal in the current environment.</p> <p>2. Check whether the wiring is correct under corresponding triggering mode.</p>
4	Live view and trigger signal are normal, but camera can't get the image required by the algorithm.	The image output format does not match.	Confirm the image format required by the algorithm and adjust the image output format of the camera in client software.
5	When live view, acquiring streams stops or image division occurs.	The PC cannot handle camera data.	<p>1. Set Device Link Throughput Limit Mode as On in Device Control.</p> <p>2. Input value in Device Link Throughput Limit, and the unit is byte. The bandwidth of camera in real-time acquisition cannot be larger than the value in Device Link Throughput Limit.</p>

## Chapter 8 Revision History

Table 8-1 Revision History

No.	Version No.	Document No.	Date	Revision Details
1	1.0.0	UD13314B	Jan. 10, 2019	Original version.



UD13314B